

CHAPTER 5

APPROACH

This chapter discusses general planning and conduct of instrument approaches by professional pilots operating under Title 14 of the Code of Federal Regulations (14 CFR) Parts 91, 121, 125, and 135. Operations specific to helicopters are covered in Appendix C. The operations specifications (OpsSpecs), standard operating procedures (SOPs), and any other Federal Aviation Administration (FAA) approved documents for each commercial operator are the final authorities for individual authorizations and limitations as they relate to instrument approaches. While coverage of the various authorizations and approach limitations for all operators is beyond the scope of this chapter, an attempt is made to give examples from generic manuals where it is appropriate.

APPROACH PLANNING

Depending on speed of the aircraft, availability of weather information, and the complexity of the approach procedure or special terrain avoidance procedures for the airport of intended landing, the inflight planning phase of an instrument approach can begin as far as 100-200 NM from the destination. Some of the approach planning should be accomplished during preflight. In general, there are five steps that most operators incorporate into their Flight Standards manuals for the inflight planning phase of an instrument approach:

- Gathering weather information, field conditions, and Notices to Airmen (NOTAMs) for the runway of intended landing.
- Calculation of performance data, approach speeds, and thrust/power settings.
- Flight deck navigation/communication and automation setup.
- Instrument approach procedure (IAP) review and, for flight crews, IAP briefing.
- Operational review and, for flight crews, operational briefing.

Although often modified to suit each individual operator, these five steps form the basic framework for the inflight planning phase of an instrument approach. The

extent of detail that a given operator includes in their SOPs varies from one operator to another; some may designate which pilot performs each of the above actions, the sequence, and the manner in which each action is performed. Others may leave much of the detail up to individual flight crews and only designate which tasks should be performed prior to commencing an approach. Flight crews of all levels, from single-pilot to multi-crewmember Part 91 operators, can benefit from the experience of commercial operators in developing techniques to fly standard instrument approach procedures (SIAPs).

Determining the suitability of a specific IAP can be a very complex task, since there are many factors that can limit the usability of a particular approach. There are several questions that pilots need to answer during preflight planning and prior to commencing an approach. Is the approach procedure authorized for the company, if Part 121, 125, or 135? Is the weather appropriate for the approach? Is the aircraft currently at a weight that will allow it the necessary performance for the approach and landing or go around/missed approach? Is the aircraft properly equipped for the approach? Is the flight crew qualified and current for the approach? Many of these types of issues must be considered during preflight planning and within the framework of each specific air carrier's OpsSpecs, or Part 91.

WEATHER CONSIDERATIONS

Weather conditions at the field of intended landing dictate whether flight crews need to plan for an instrument approach and, in many cases, determine which approaches can be used, or if an approach can even be attempted. The gathering of weather information should be one of the first steps taken during the approach-planning phase. Although there are many possible types of weather information, the primary concerns for approach decision-making are wind speed, wind direction, ceiling, visibility, altimeter setting, temperature, and field conditions. It is also a good idea to check NOTAMs at this time in case there were any changes since preflight planning.

Wind speed and direction are factors because they often limit the type of approach that can be flown at

a specific location. This typically is not a factor at airports with multiple precision approaches, but at airports with only a few or one approach procedure the wrong combination of wind and visibility can make all instrument approaches at an airport unavailable. As an example, consider the available approaches at the Chippewa Valley Regional Airport (KEAU) in Eau Claire, Wisconsin, shown in figure 5-1. In the event that the visibility is reported as less than one mile, the only useable approach for category C airplanes is the Instrument Landing System (ILS) to Runway 22. This leaves very few options for flight crews if the wind does not favor Runway 22; and, in cases where the wind restricts a landing on that runway altogether, even a circling approach cannot be flown because of the visibility.

WEATHER SOURCES

Most of the weather information that flight crews receive is issued to them prior to the start of each flight segment, but the weather used for inflight planning and execution of an instrument approach is normally obtained en route via government sources, company frequency, or Aircraft Communications Addressing and Reporting System (ACARS).

Air carriers and operators certificated under the provisions of Part 119 (Certification: Air Carriers and Commercial Operators) are required to use the aeronautical weather information systems defined in the OpsSpecs issued to that certificate holder by the FAA. These systems may use basic FAA/National Weather Service (NWS) weather services, contractor or operator-proprietary weather services and/or Enhanced Weather Information System (EWINS) when approved in the OpsSpecs. As an integral part of EWINS approval, the procedures for collecting, producing and disseminating aeronautical weather information, as well as the crewmember and dispatcher training to support the use of system weather products, must be accepted or approved.

Operators not certificated under the provisions of Part 119 are encouraged to use FAA/NWS products through Automated Flight Service Stations (AFSSs), Direct User Access Terminal System (DUATS), and/or Flight Information Services Data Link (FISDL). Refer to the *Aeronautical Information Manual* (AIM) for more information regarding AFSSs, DUATS, and FISDL.

The suite of available aviation weather product types is expanding with the development of new sensor systems, algorithms and forecast models. The FAA and NWS, supported by the National Center for Atmospheric Research and the Forecast Systems Laboratory, develop and implement new aviation

weather product types through a comprehensive process known as the Aviation Weather Technology Transfer process. This process ensures that user needs and technical and operational readiness requirements are met as experimental product types mature to operational application.

The development of enhanced communications capabilities, most notably the Internet, has allowed pilots access to an ever-increasing range of weather service providers and proprietary products. It is not the intent of the FAA to limit operator use of this weather information. However, pilots and operators should be aware that weather services provided by entities other than the FAA, NWS, or their contractors (such as the DUATS and FISDL providers) may not meet FAA/NWS quality control standards. Therefore, operators and pilots contemplating using such services should consider the following in determining the suitability of that service or product. In many cases, this may be accomplished by provider disclosure or a description of services or products:

Is the service or product applicable for aviation use?

- Does the product or service provide information that is usable in aeronautical weather decision-making?
- Does the product or service fail to provide data necessary to make critical aeronautical weather decisions?

Does the service provide data/products produced by approved aviation weather information sources?

- Is this data or product modified?
- If so, is the modification process described, and is the final product in a configuration that supports aeronautical weather decision-making?

Are the weather products professionally developed and produced and/or quality-controlled by a qualified aviation meteorologist?

Does the provider's quality assurance plan include the capability to monitor generated products and contain a procedure to correct deficiencies as they are discovered?

Is the product output consistent with original data sources?

Are education and training materials sufficient to enable users to use the new product effectively?

Are the following key elements of the product intuitive and easy for the user to interpret?

- Type of data/product.
- Currency or age of data/product.

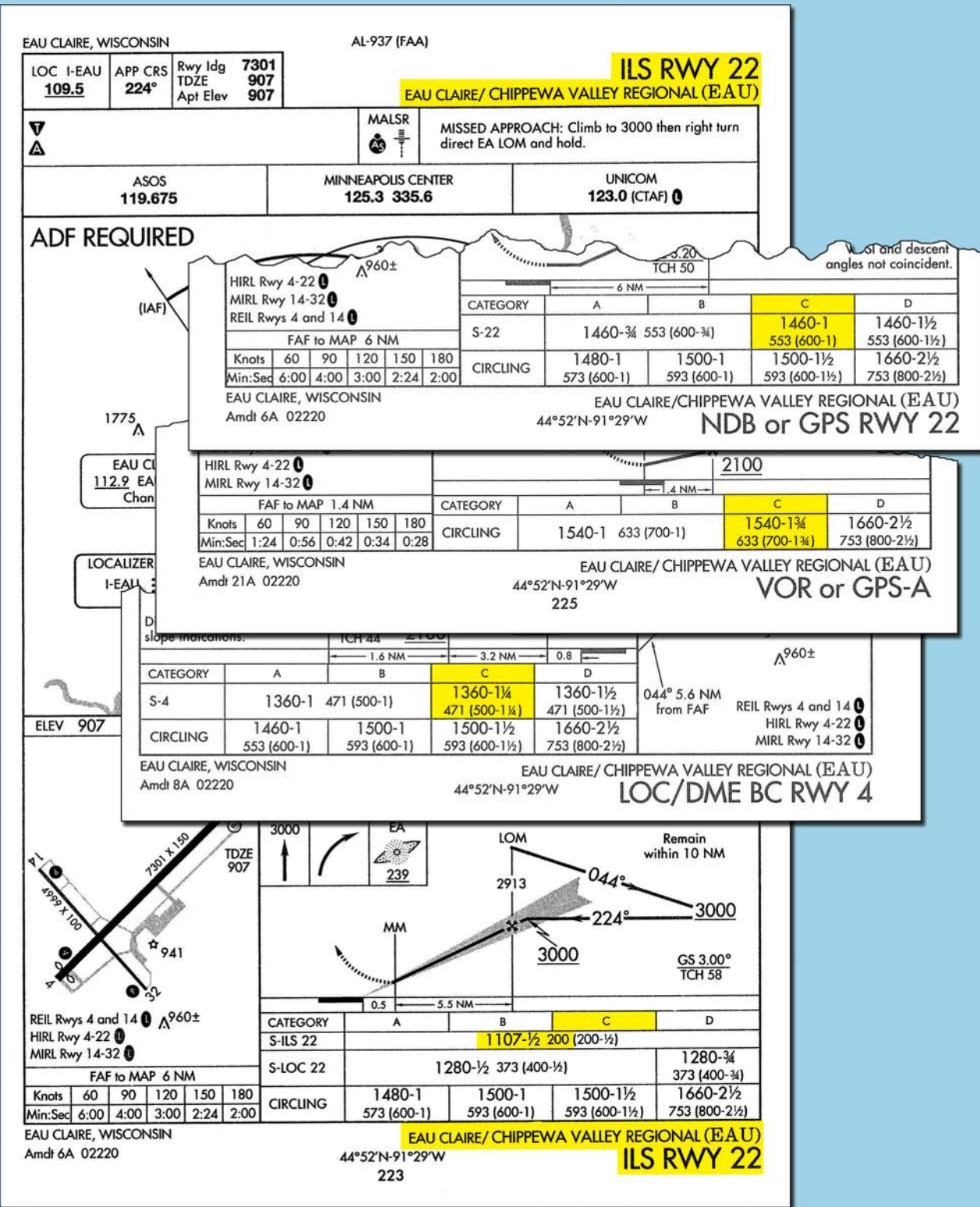

Figure 5-1. Chippewa Regional Airport (KEAU), Eau Claire, Wisconsin.

- Method for displaying and decoding the data/product.
- Location/mapping of the data.

Is the product suitable for use? Consider potential pilot misunderstandings due to:

- Complexity of the product.
- Nonstandard display (colors, labels).
- Incorrect mapping/display of data.
- Incorrect overlay of weather data with other data (terrain, navigational aids (NAVAIDs), waypoints, etc.).
- Inappropriate display of missing data.
- Missing or inaccurate time/date stamp on product.

Pilots and operators should be cautious when using unfamiliar products, or products not supported by technical specifications that satisfy the considerations noted above.

NOTE: When in doubt, use FAA/NWS products with the consultation of an FAA AFSS specialist.

BROADCAST WEATHER

The most common method used by flight crews to obtain specific inflight weather information is to use a source that broadcasts weather for the specific airport. Information about ceilings, visibility, wind, temperature, barometric pressure, and field conditions can be obtained from most types of broadcast weather services. Broadcast weather can be transmitted to the aircraft in radio voice format or digital format, if it is available, via an ACARS system.

AUTOMATIC TERMINAL INFORMATION SERVICE

The weather broadcast system found most often at airports with air traffic control towers in the National Airspace System (NAS) is the automatic terminal information service (ATIS). The AIM defines ATIS as the continuous broadcast of recorded non-control information in selected high activity terminal areas. The main purpose of ATIS is the reduction of frequency congestion and controller workload. It is broadcast over very high frequency (VHF) radio frequencies, and is designed to be receivable up to 60 NM from the transmitter at altitudes up to 25,000 feet above ground level (AGL). ATIS is typically derived from an automated weather observation system or a human weather observer's report.

AUTOMATED WEATHER OBSERVING PROGRAMS

Automated surface observation systems can provide pilots with weather information over discrete VHF frequencies or over the voice portion of local NAVAIDs.

The automated weather observing system (AWOS) and automated surface observing system (ASOS) provide real-time weather information that can be used by flight crews to make approach decisions, and by the NWS to generate aviation routine weather reports (METARs). Flight crews planning approaches to airports where ATIS is not available may be able to obtain current airport conditions from an AWOS/ASOS facility.

FAA-owned and operated AWOS-2 and AWOS-3 systems are approved sources of weather for Part 121 and 135 operations. Also, NWS-operated ASOSs are approved sources of weather for Part 121 and 135 operations. An AWOS/ASOS cannot be used as an authorized weather source for Part 121 or 135 instrument flight rules (IFR) operations if the visibility or altimeter setting is reported missing from the report. Refer to the AIM for the most current information on automated weather observation systems.

CENTER WEATHER

In the event that an airport has weather observation capability, but lacks the appropriate equipment to transmit that information over a radio frequency, air route traffic control centers (ARTCCs) can provide flight crews with hourly METAR or non-routine aviation weather report (SPECI) information for those airports. The flight watch frequency for the geographic area of the flight will also have a current METAR or SPECI for an airport of this kind.

REGULATORY REQUIREMENTS

There are many practical reasons for reviewing weather information prior to initiating an instrument approach. Pilots must familiarize themselves with the condition of individual airports and runways so that they may make informed decisions regarding fuel management, diversions, and alternate planning. Because this information is critical, CFRs require pilots to comply with specific weather minimums for planning and execution of instrument flights and approaches.

PART 91 OPERATORS

According to Part 91.103, the pilot in command shall become familiar with all available information concerning a flight prior to departure. Included in this directive is the fundamental basis for pilots to review NOTAMs and pertinent weather reports and forecasts for the intended route of flight. This review should include current weather reports and terminal forecasts for all intended points of landing and alternate airports. In addition, a thorough review of an airport's current weather conditions should always be conducted prior to initiating an instrument approach. Although there is no regulatory requirement for Part 91 operators to do so, reviewing current weather conditions can assist the pilot in forming expectations about the outcome of the

approach. Pilots should also consider weather information as a planning tool for fuel management.

For flight planning purposes, weather information must be reviewed in order to determine the necessity and suitability of alternate airports. For Part 91 operations, the 600-2 and 800-2 rule applies to airports with precision and nonprecision approaches, respectively. Approaches with vertical guidance (APV) are considered nonprecision. (See Final Approach Segment section later in this chapter for more information regarding APV approaches.) Exceptions to the 600-2 and 800-2 alternate minimums are listed in the front of the National Aeronautical Charting Office (NACO) *U.S. Terminal Procedures Publication (TPP)* and are indicated by an “A” symbol on the approach charts for the airport. This does not preclude flight crews from initiating instrument approaches at alternate airports when the weather conditions are below these minimums. The 600-2 and 800-2 rules, or any exceptions, only apply to flight planning purposes, while published landing minimums apply to the actual approach at the alternate.

PART 135 OPERATORS

Unlike Part 91 operators, Part 135 operators may not depart for a destination unless the forecast weather there will allow an instrument approach and landing. According to Part 135.219, flight crews and dispatchers may only designate an airport as a destination if the latest weather reports or forecasts, or any combination of them, indicate that the weather conditions will be at or above IFR landing minimums at the estimated time of arrival (ETA). This ensures that Part 135 flight crews consider weather forecasts when determining the suitability of destinations. Departures for airports can be made when the forecast weather shows the airport will be at or above IFR minimums at the ETA, even if current conditions indicate the airport to be below minimums. Conversely, Part 135.219 prevents departures when the first airport of intended landing is currently above IFR landing minimums, but the forecast weather is below those minimums at the ETA.

Another very important difference between Part 91 and Part 135 operations is the Part 135 requirement for airports of intended landing to meet specific weather criteria once the flight has been initiated. For Part 135, not only is the weather required to be forecast at or above IFR landing minimums for planning a departure, but it also must be above minimums for initiation of an instrument approach and, once the approach is initiated, to begin the final approach segment of an approach. Part 135.225 states that pilots may not begin an instrument approach or the final approach segment of an IAP to an airport unless the latest weather report indicates that the weather conditions

are at or above the authorized IFR landing minimums for that procedure. This means that Part 135 operators are restricted from passing the initial approach fix (IAF) and the final approach fix (FAF) if the weather is reported below minimums. Part 135.225 also provides relief from this rule if the aircraft has already passed the FAF when the weather report is received. It should be noted that the controlling factor for determining whether or not the aircraft can proceed beyond the IAF or FAF is reported visibility. Runway visual range (RVR), if available, is the controlling visibility report for determining that the requirements of this section are met. The runway visibility value (RVV), reported in statute miles (SM), takes precedent over prevailing visibility. There is no required timeframe for receiving current weather prior to initiating the approach.

PART 121 OPERATORS

Like Part 135 operators, flight crews and dispatchers operating under Part 121 must ensure that the appropriate weather reports or forecasts, or any combination thereof, indicate that the weather will be at or above the authorized minimums at the ETA at the airport to which the flight is dispatched (Part 121.613). This regulation attempts to ensure that flight crews will always be able to execute an instrument approach at the destination airport. Of course, weather forecasts are occasionally inaccurate; therefore, a thorough review of current weather is required prior to conducting an approach. Like Part 135 operators, Part 121 operators are restricted from proceeding past the FAF of an instrument approach unless the appropriate IFR landing minimums exist for the procedure. In addition, descent below the **minimum descent altitude (MDA)**, **decision altitude (DA)**, or **decision height (DH)** is governed, with one exception, by the same rules that apply to Part 91 operators. The exception is that during Part 121 and 135 operations, the airplane is also required to land within the touchdown zone (TDZ). Refer to the section titled Minimum Descent Altitude, Decision Altitude, and Decision Height later in this chapter for more information regarding MDA, DA, and DH.

PERFORMANCE CONSIDERATIONS

All operators are required to comply with specific airplane performance limitations that govern approach and landing. Many of these requirements must be considered prior to the origination of flight. The primary goal of these performance considerations is to ensure that the aircraft can remain clear of obstructions throughout the approach, landing, and go-around phase of flight, as well as land within the distance required by the FAA. Although the majority of in-depth performance planning for an instrument flight is normally done prior to the aircraft’s departure, a general

review of performance considerations is usually conducted prior to commencing an instrument approach.

AIRPLANE PERFORMANCE OPERATING LIMITATIONS

Generally speaking, air carriers must have in place an approved method of complying with Subpart I of Parts 121 and 135 (Airplane Performance Operating Limitations), thereby proving the airplane's performance capability for every flight that it intends to make. Flight crews must have an approved method of complying with the approach and landing performance criteria in the applicable regulations prior to departing for their intended destination. The primary source of information for performance calculations for all operators, including Part 91, is the approved Aircraft Flight Manual (AFM) or Pilot's Operating Handbook (POH) for the make and model of aircraft that is being operated. It is required to contain the manufacturer determined performance capabilities of the aircraft at each weight, altitude, and ambient temperature that are within the airplane's listed limitations. Typically, the AFM for a large turbine powered airplane must contain information that allows flight crews to determine that the airplane will be capable of performing

the following actions, considering the airplane's landing weight and other pertinent environmental factors:

- Land within the distance required by the regulations.
- Climb from the missed approach point (MAP) and maintain a specified climb gradient with one engine inoperative.
- Perform a go-around from the final stage of landing and maintain a specified climb gradient with all engines operating and the airplane in the landing configuration.

Many airplanes have more than one allowable flap configuration for normal landing. Often, a reduced flap setting for landing will allow the airplane to operate at a higher landing weight into a field that has restrictive obstacles in the missed approach or rejected landing climb path. On these occasions, the full-flap landing speed may not allow the airplane enough energy to successfully complete a go-around and avoid any high terrain that might exist on the climb out. Therefore, all-engine and engine-out missed approaches, as well as rejected landings, must be taken into consideration in compliance with the regulations. [Figure 5-2]

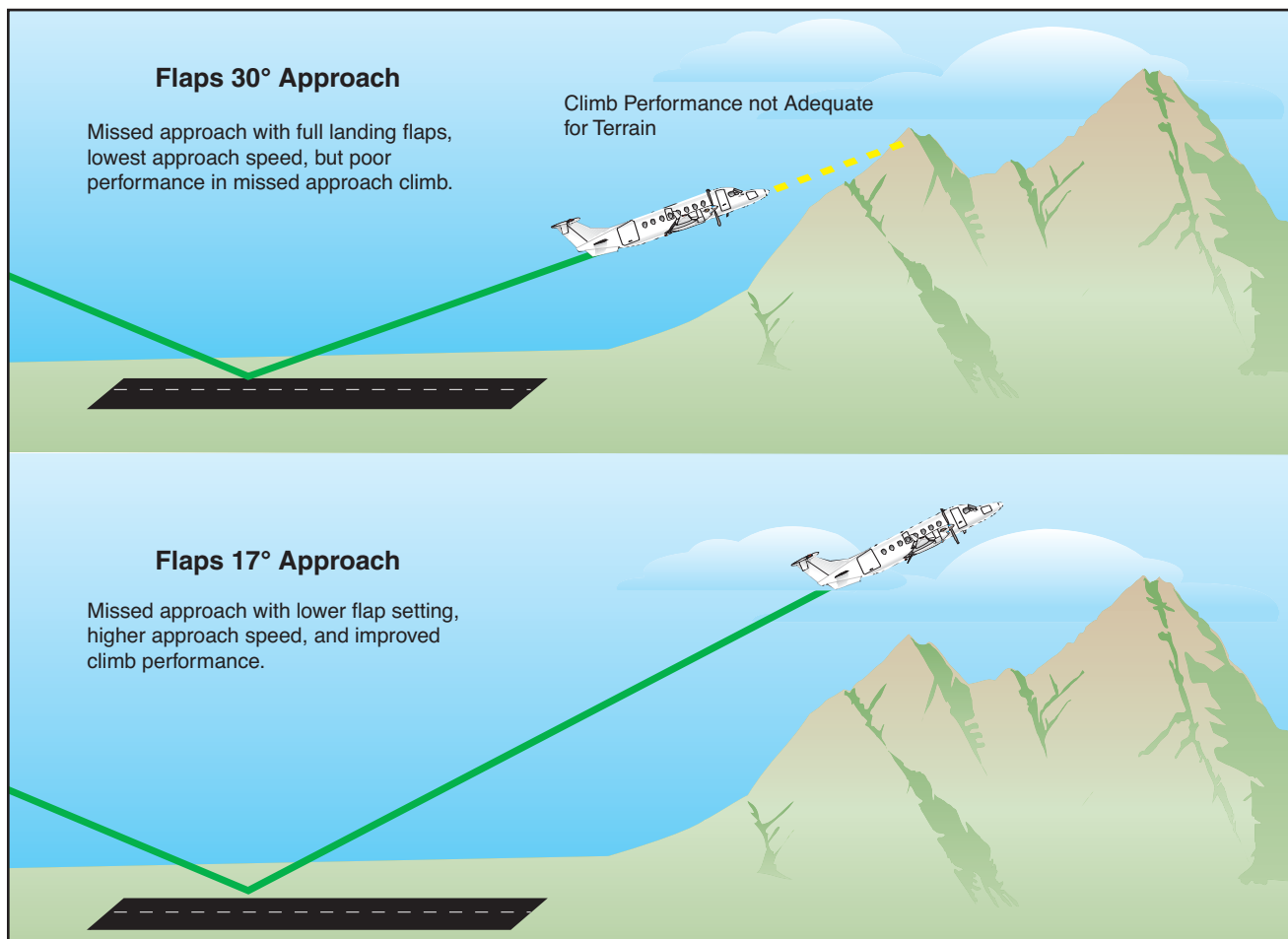

Figure 5-2. Reduced Flap Settings Effect on Go-Around.

APPROACH SPEED AND CATEGORY

Two other critical performance factors that should be considered during the planning phase of an instrument approach are aircraft approach category and planned approach speed. According to the December 26, 2002 amendment of Part 97.3 (b), **aircraft approach category** means a grouping of aircraft based on **reference landing speed (V_{REF})**, if specified, or if V_{REF} is not specified, $1.3 V_{S0}$ (the stalling speed or minimum steady flight speed in the landing configuration) at the maximum certificated landing weight. V_{REF} , V_{S0} , and the maximum certificated landing weight are those values as established for the aircraft by the certification authority of the country of registry. The categories are as follows:

- Category A: Speed less than 91 knots.
- Category B: Speed 91 knots or more but less than 121 knots.
- Category C: Speed 121 knots or more but less than 141 knots.
- Category D: Speed 141 knots or more but less than 166 knots.
- Category E: Speed 166 knots or more.

Pilots are responsible for determining and briefing which category minimums will be used for each instrument approach. If a higher approach speed is used on final that places the aircraft in a higher approach category, the minimums for the higher category must be used. Approaches made with inoperative flaps, circling approaches at higher-than-normal straight-in approach speeds, and approaches made in icing conditions for some types of airplanes are all examples of situations that can necessitate the use of a higher approach category. Since an approach category can make a difference in the approach and weather minimums and, in some cases, prohibit flight crews from initiating an approach, the approach speed should be calculated and the effects on the approach determined and briefed in the preflight planning phase, as well as reviewed prior to commencing an approach.

OPERATIONAL CONSIDERATIONS

Most commercial operators dictate standard procedures for conducting instrument approaches in their FAA approved manuals. These standards designate company callouts, flight profiles, configurations, and other

specific duties for each cockpit crewmember during the conduct of an instrument approach.

APPROACH CHART FORMATS

Beginning in February 2000, NACO began issuing the current format for IAPs. This chart was developed by the Department of Transportation, Volpe National Transportation Systems Center and is commonly referred to as the **Pilot Briefing Information** format. The changeover process is to be completed by December 2003. There are several advantages to the new NACO chart format since the information is presented in a logical order, facilitating pilot briefing of the procedures. [Figure 5-3] Additional information relating to the Pilot Briefing Information and classic NACO approach chart formats can be found in Appendix B — Approach Chart Format Changes.

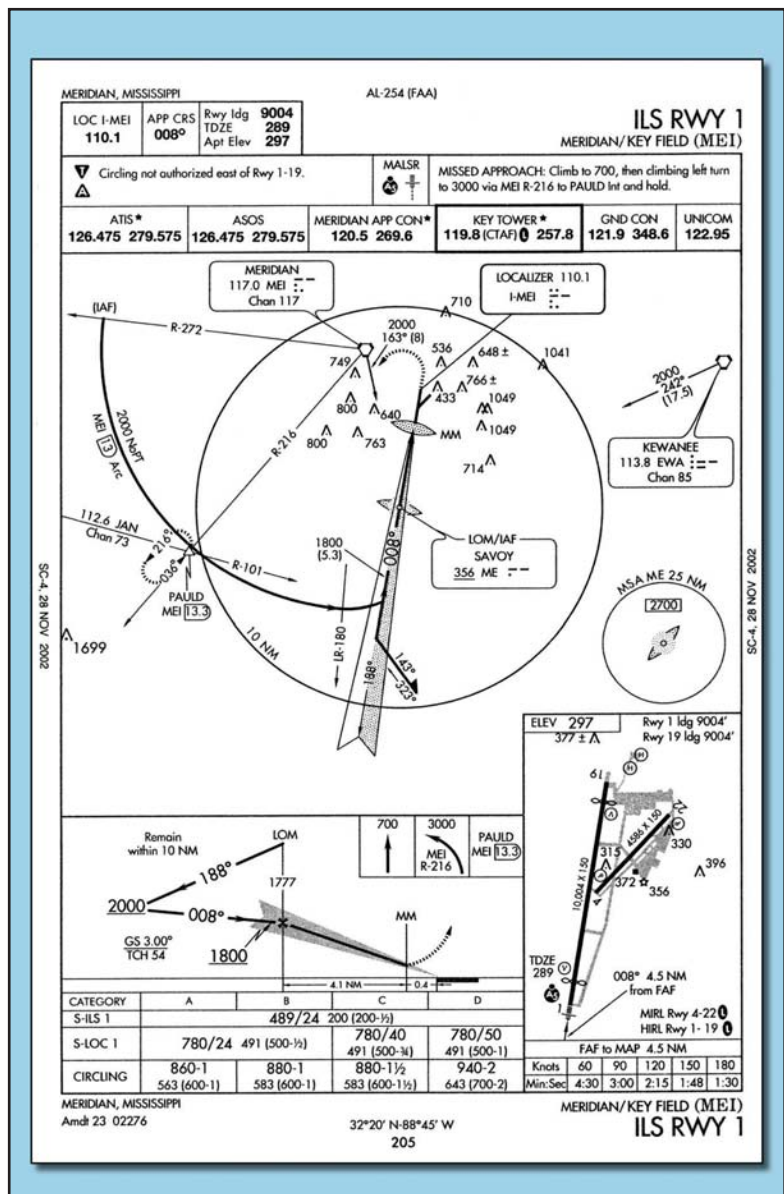

Figure 5-3. Pilot Briefing Information NACO Chart Format.

APPROACH CHART NAMING CONVENTIONS

Individual NACO charts are identified on both the top and the bottom of the page by their procedure name (based on the NAVAIDs required for the final approach), runway served, and airport location. The identifier for the airport is also listed immediately after the airport name, as shown in figure 5-4.

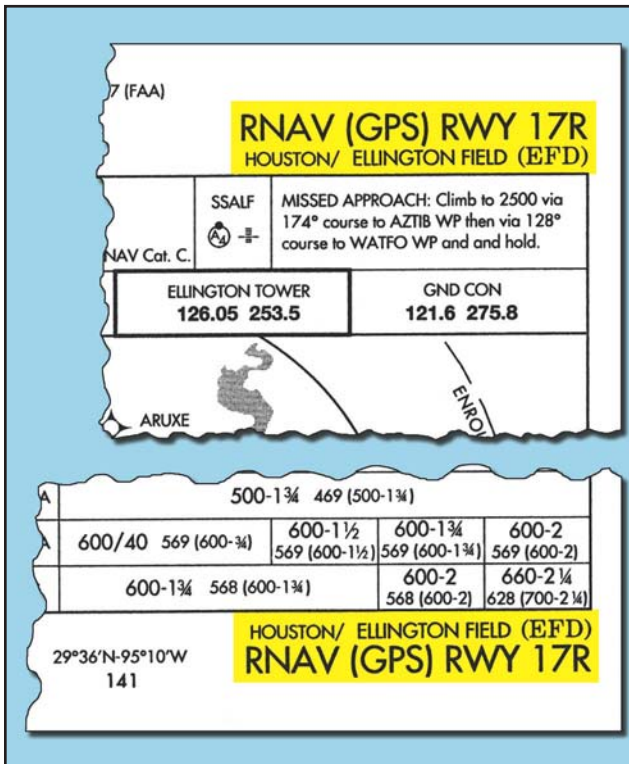

Figure 5-4. Chart Identification.

There are several types of approach procedures that may cause some confusion for flight crews unfamiliar with the naming conventions. Although specific information about each type of approach will be covered later in this chapter, here are a few procedure names that can cause confusion.

STRAIGHT-IN PROCEDURES

When two or more straight-in approaches with the same type of guidance exist for a runway, a letter suffix is added to the title of the approach so that it can be more easily identified. These approach charts start with the letter Z and continue in reverse alphabetical order. For example, consider the RNAV (GPS) Z RWY 10R and RNAV (GPS) Y RWY 10R approaches at San Francisco International Airport. [Figure 5-5] These two approaches to the same runway are slightly different, one includes an intermediate step-down fix and the other does not; and one allows the use of vertical navigation (VNAV) and the other does not. In order to differentiate the approaches, the FAA has labeled them Z and Y. This convention

also eliminates any confusion with approach procedures labeled A and B, where only circling minimums are published. The designation of two area navigation (RNAV) procedures to the same runway can occur when it is desirable to accommodate panel mounted global positioning system (GPS) receivers and flight management systems (FMSs), both with and without VNAV. It is also important to note that only one of each type of approach for a runway, including ILS, VHF omnidirectional range (VOR), non-directional beacon (NDB), etc., can be coded into a database.

CIRCLING ONLY PROCEDURES

Approaches that do not have straight-in landing minimums are identified by the type of approach followed by a letter. Examples in figure 5-6 show four procedure titles at the same airport that have only circling minimums.

As can be seen from the example, the first approach of this type created at the airport will be labeled with the letter A, and the lettering will continue in alphabetical order. Circling-only approaches are normally designed for one of the following reasons:

- The final approach course alignment with the runway centerline exceeds 30°.
- The descent gradient is greater than 400 feet per NM from the FAF to the threshold crossing height (TCH). When this maximum gradient is exceeded, the circling only approach procedure may be designed to meet the gradient criteria limits. This does not preclude a straight-in landing if a normal descent and landing can be made in accordance with the applicable CFRs.

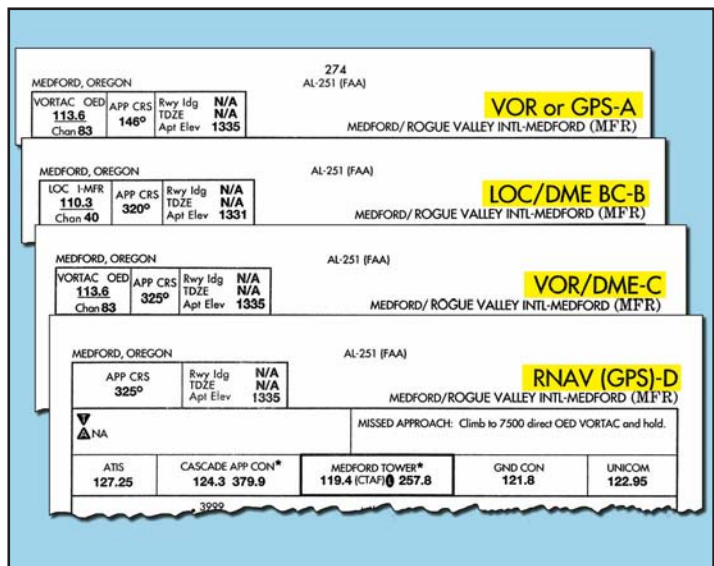

Figure 5-6. Procedures without Straight-in Landing Minimums.

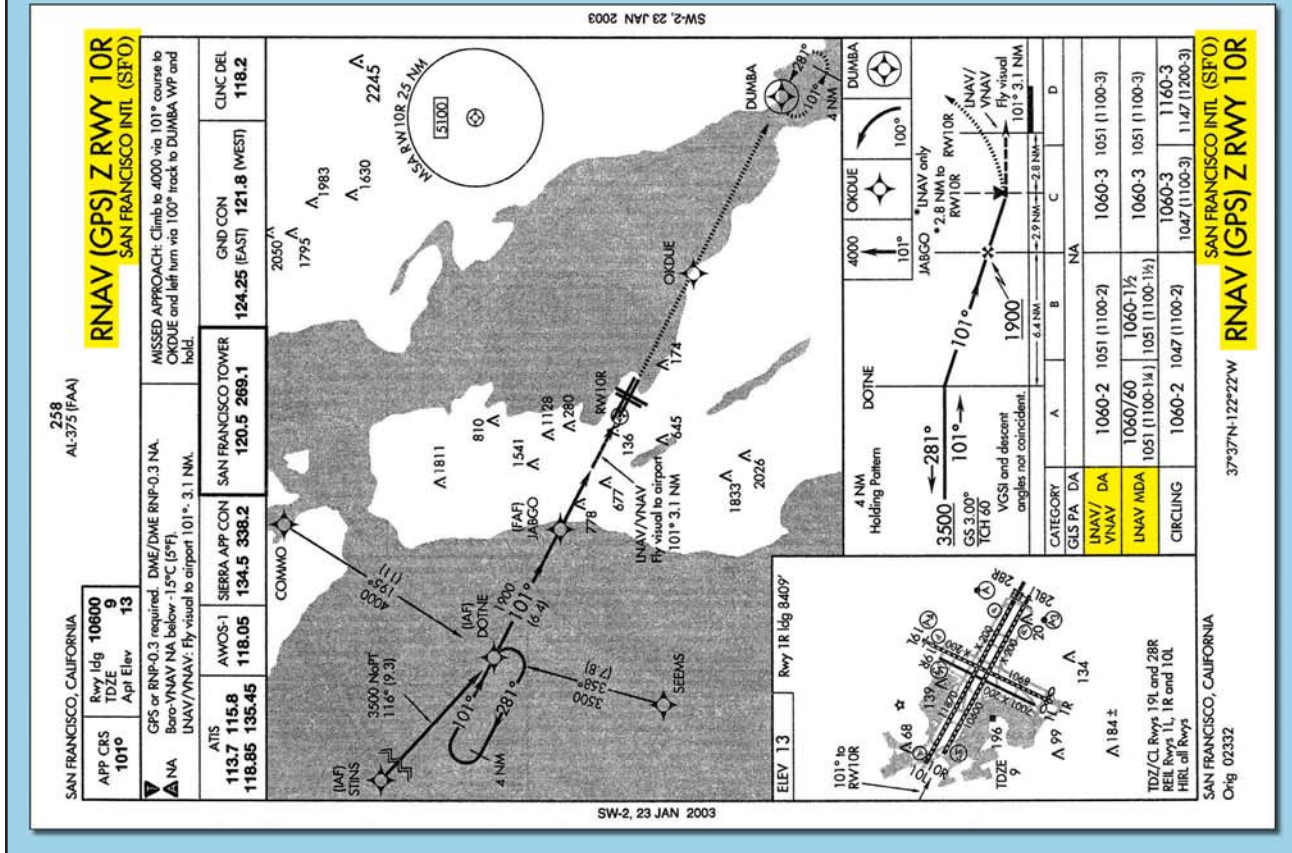
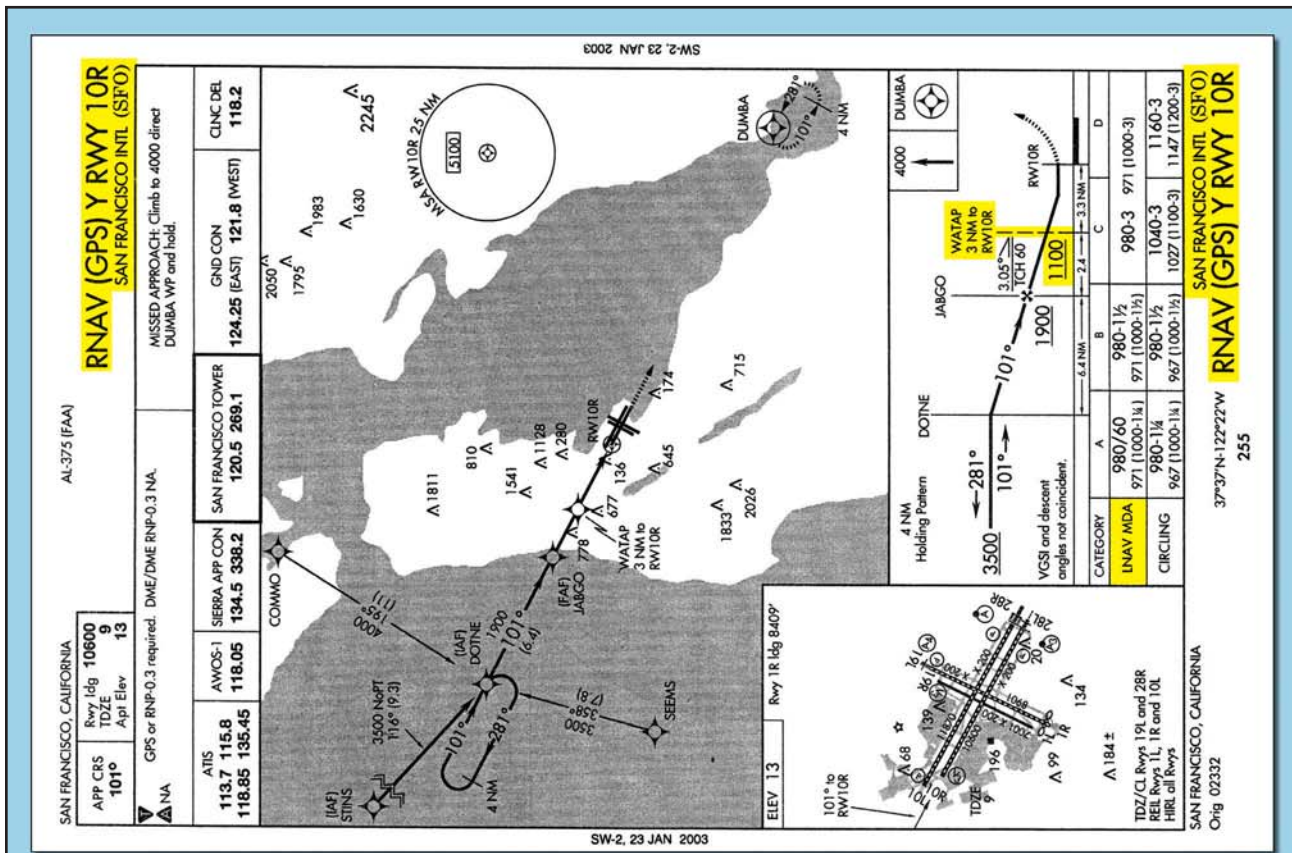

Figure 5-5. Multiple Approaches.

AREA NAVIGATION APPROACHES

VOR distance-measuring equipment (DME) RNAV approach procedures that use collocated VOR and DME information to construct RNAV approaches are named “VOR/DME RNAV RWY XX,” where XX stands for the runway number for which the approach provides guidance. Sometimes referred to as “station mover” approaches, these procedures were the first RNAV approaches issued by the FAA. They enable specific VOR/DME RNAV equipment to create waypoints on the final approach path by virtually “moving” the VOR a specific DME distance along a charted radial. [Figure 5-7]

GPS overlay procedures that are based on pre-existing nonprecision approaches contain the wording “or GPS” in the title. For instance, the title “VOR/DME or GPS A” denotes that throughout the GPS approach, the underlying ground-based NAVAIDs are not required to be operational and associated aircraft avionics need not be installed, operational, turned on, or monitored. [Figure 5-8] Monitoring of the underlying approach is suggested when equipment is available and functional.

The procedure can be used as a GPS approach or as a traditional VOR/DME approach and may be requested using “GPS” or “VOR/DME,” such as “GPS A” for the VOR/DME or GPS A. As previously mentioned, the “A” in the title shows that this is a circling approach without straight-in minimums. Many GPS overlay procedures have been replaced by stand-alone GPS or RNAV (GPS) procedures.

Stand-alone GPS procedures are not based on any other procedures, but they may replace other procedures. The naming convention used for stand-alone GPS approaches is “GPS RWY XX.” The coding for the approach in the database does not accommodate multi-sensor FMSs because these procedures are designed only to accommodate aircraft using GPS equipment. These procedures will eventually be converted to RNAV (GPS) approaches. [Figure 5-9]

RNAV (GPS) approach procedures have been developed in an effort to accommodate all RNAV systems, including multi-sensor FMSs used by airlines and

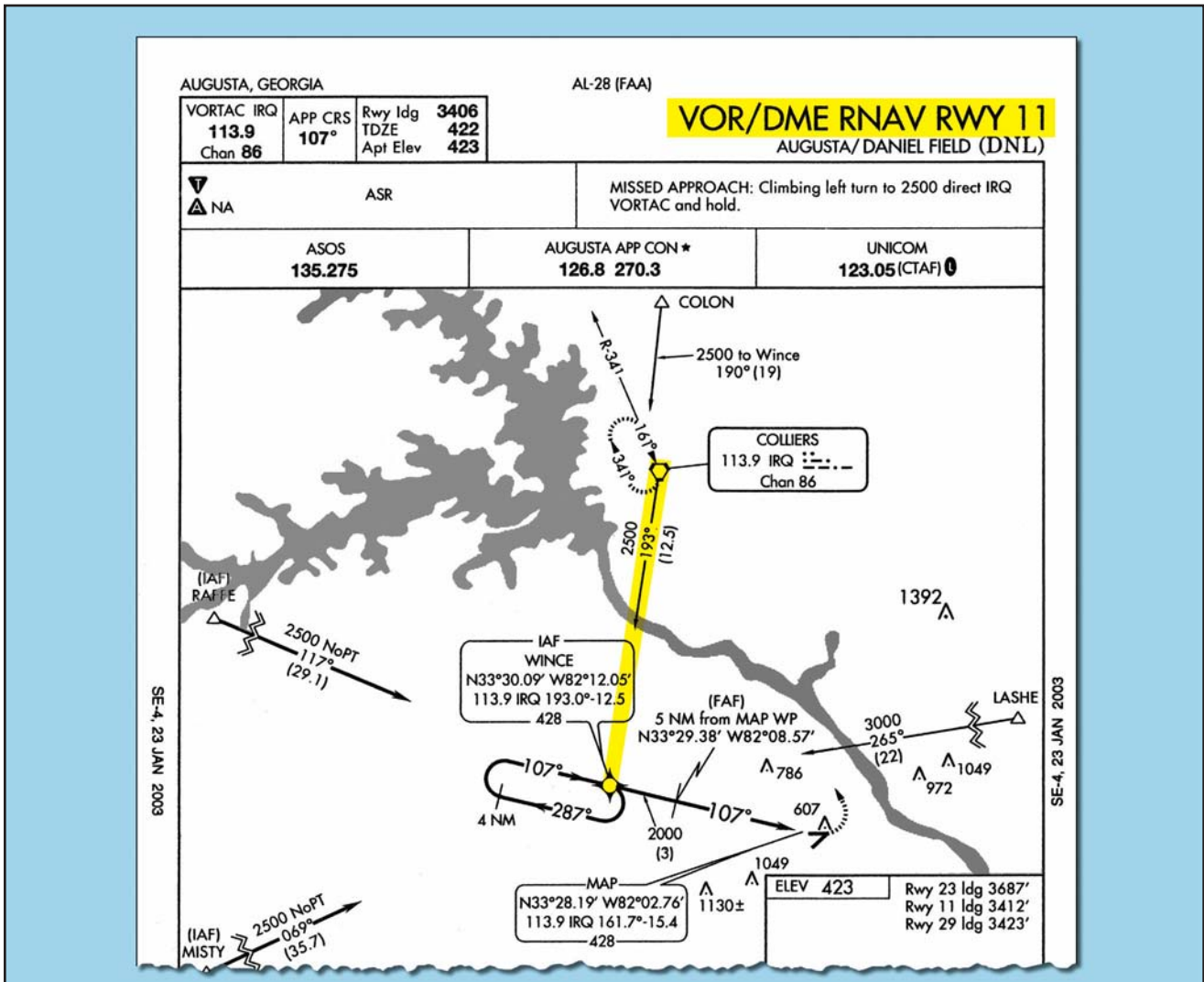

Figure 5-7. VOR/DME RNAV Approach Chart.

“(GPS),” with GPS in parentheses. “GPS” is not included in the ATC approach clearance for these procedures.

COMMUNICATIONS

The communication strip provided near the top of NACO approach charts gives flight crews the frequencies that they can expect to be assigned during the approach. The frequencies are listed in the logical order of use from arrival to touchdown. Having this information immediately available during the approach reduces the chances of a loss of contact between ATC and flight crews during this critical phase of flight.

It is important for flight crews to understand their responsibilities with regard to communications in the various approach environments. There are numerous differences in communication responsibilities when operating into and out of airports without air traffic control towers as compared to airports with control towers. Today’s professional pilots face an ever-increasing range of ATC environments and conflicting traffic dangers, making approach briefing and preplanning even more critical. Individual company operating manuals and SOPs dictate the duties for each crewmember.

Advisory Circular 120-71, *Standard Operating Procedures for Flight Deck Crewmembers*, contains the following concerning ATC communications:

ATC Communications: SOPs should state who (Pilot Flying [PF], Pilot Not Flying [PNF], Flight Engineer/Second Officer) handles the radios for each phase of flight, as follows:

PF makes input to aircraft/autopilot and/or verbally states clearances while PNF confirms that the input is what he/she read back to ATC.

Requesting ATC confirmation immediately clears up any confusion on the flight deck.

If any crewmember is off the flight deck, all ATC instructions are briefed upon his/her return. Or if any crewmember is off the flight deck all ATC instructions are written down until his/her return and then passed to that crewmember upon return. Similarly, if a crewmember is off ATC frequency (e.g., when making a PA announcement or when talking on company frequency), all ATC instructions are briefed upon his/her return to the frequency.

Company crew resource management policy should address use of speakers, headsets, boom mikes, and/or hand-held mikes.

APPROACH CONTROL

Approach control is responsible for controlling all instrument flights operating within its area of responsibility. Approach control may serve one or more airports. Control is exercised primarily through direct pilot and controller communication and airport surveillance radar (ASR). Prior to arriving at the IAF, instructions will be received from ARTCC to contact approach control on a specified frequency. Where radar is approved for approach control service, it is used not only for radar approaches, but also for vectors in conjunction with published non-radar approaches using conventional NAVAIDs or RNAV/GPS.

When radar handoffs are initiated between the ARTCC and approach control, or between two approach control facilities, aircraft are cleared (with vertical separation) to an outer fix most appropriate to the route being flown and, if required, given holding instructions. Or, aircraft are cleared to the airport or to a fix so located that the handoff will be completed prior to the time the aircraft reaches the fix. When radar handoffs are used, successive arriving flights may be handed off to approach control with radar separation in lieu of vertical separation.

After release to approach control, aircraft are vectored to the final approach course. ATC will occasionally vector the aircraft across the final approach course for spacing requirements. The pilot is not expected to turn inbound on the final approach course unless an approach clearance has been issued. This clearance will normally be issued with the final vector for interception of the final approach course, and the vector will enable the pilot to establish the aircraft on the final approach course prior to reaching the FAF.

AIR ROUTE TRAFFIC CONTROL CENTER

ARTCCs are approved for and may provide approach control services to specific airports. The radar systems used by these Centers do not provide the same precision as an ASR or precision approach radar (PAR) used by approach control facilities and control towers, and the update rate is not as fast. Therefore, pilots may be requested to report established on the final approach course. Whether aircraft are vectored to the appropriate final approach course or provide their own navigation on published routes to it, radar service is automatically terminated when the landing is completed; or when instructed to change to advisory frequency at airports without an operating air traffic control tower, whichever occurs first. When arriving on an IFR flight plan at an airport with an operating control tower, the flight plan will be closed automatically upon landing.

The extent of services provided by approach control varies greatly from location to location. The majority of

Durango VOR may be restricted to a minimum IFR altitude (MIA) of 17,000 feet mean sea level (MSL) due to unavailability of Center radar coverage in that area at lower altitudes. An arrival on V95 from the northeast would be able to descend to a minimum en route altitude (MEA) of 12,000 feet, allowing a shallower transition to the approach environment. An off-route arrival may necessitate a descent in the published holding pattern over the DRO VOR to avoid an unstable approach into Durango.

- Lack of approach control terrain advisories – Flight crews must understand that terrain clearance cannot be assured by ATC when aircraft are operating at altitudes that are not served by Center or approach radar. Strict adherence to published routes and minimum altitudes is necessary to avoid a controlled flight into terrain (CFIT) accident. Flight crews should always familiarize themselves with terrain features and obstacles depicted on approach charts prior to initiating the approach. Approaches outside of radar surveillance require enhanced awareness of this information.
- Lack of approach control traffic advisories – If radar service is not available for the approach, the ability of ATC to give flight crews accurate traffic advisories is greatly diminished. In some cases, the common traffic advisory frequency (CTAF) may be the only tool available to enhance an IFR flight's awareness of traffic at the destination airport. Additionally, ATC will not clear an IFR flight for an approach until the preceding aircraft on the approach has cancelled IFR, either on the ground, or airborne once in visual meteorological conditions (VMC).

AIRPORTS WITH AN AIR TRAFFIC CONTROL TOWER

Towers are responsible for the safe, orderly, and expeditious flow of all traffic that is landing, taking off, operating on and in the vicinity of an airport and, when the responsibility has been delegated, towers also provide for the separation of IFR aircraft in terminal areas. Aircraft that are departing IFR are integrated into the departure sequence by the tower. Prior to takeoff, the tower controller coordinates with departure control to assure adequate aircraft spacing.

AIRPORTS WITHOUT AN AIR TRAFFIC CONTROL TOWER

From a communications standpoint, executing an instrument approach to an airport that is not served by an ATC tower is much the same as making a visual approach to that airport. Flight crews are expected to self-announce their arrival into the

vicinity of the airport no later than 10 NM from the field. Depending on the weather, as well as the amount and type of conflicting traffic that exists in the area, an approach to an airport without an operating air traffic control tower will increase the difficulty of the transition to visual flight. In many cases, a commercial or charter flight arriving via an instrument approach will need to mix in with visual flight rules (VFR) traffic operating in the vicinity of the field, without the benefit of a control tower sequencing the traffic to the runway. For this reason, many companies require that flight crews make contact with the arrival airport CTAF or company operations personnel via a secondary radio over 25 NM from the field in order to receive traffic advisories. In addition, crews should attempt to listen to the CTAF well in advance of their arrival in order to determine the VFR traffic situation.

Since separation cannot be provided between IFR and VFR traffic when operating in areas where there is no radar coverage, pilots are expected to make radio announcements on the CTAF. These announcements allow other aircraft operating in the vicinity to plan their departures and arrivals with a minimum of conflicts. In addition, it is very important for crews to maintain a listening watch on the CTAF to increase their awareness of the current traffic situation. Flights inbound on an instrument approach to a field without a control tower should make several self-announced radio calls during the approach:

- Initial call within 5-10 minutes of the aircraft's arrival at the IAF. This call should give the aircraft's location as well as the crew's approach intentions.
- Departing the IAF, stating the approach that is being initiated.
- Procedure turn (or equivalent) inbound.
- FAF inbound, stating intended landing runway and maneuvering direction if circling.
- Short final, giving traffic on the surface notification of imminent landing.

When operating on an IFR flight plan at an airport without a functioning control tower, pilots must initiate cancellation of the IFR flight plan with ATC or an AFSS. Remote communications outlets (RCOs) or ground communications outlets (GCOs), if available, can be used to contact an ARTCC or an AFSS after landing. If a frequency is not available on the ground, the pilot has the option to cancel IFR while in flight if VFR conditions can be maintained while in contact with ARTCC, as long as those conditions can be maintained until landing. Additionally, pilots can relay a

proceed via the holding fix which was the last assigned route, and the feeder route associated with that fix, if a feeder route is published on the approach chart, to the IAF to commence the approach. When cleared for the approach, the published off-airway (feeder) routes that lead from the en route structure to the IAF are part of the approach clearance.

If a feeder route to an IAF begins at a fix located along the route of flight prior to reaching the holding fix, and clearance for an approach is issued, a pilot should commence the approach via the published feeder route; for example, the aircraft would not be expected to overfly the feeder route and return to it. The pilot is expected to commence the approach in a similar manner at the IAF, if the IAF for the procedure is located along the route of flight to the holding fix.

If a route of flight directly to the IAF is desired, it should be so stated by the controller with phraseology to include the words “*direct...*,” “*proceed direct...*,” or a similar phrase that the pilot can interpret without question. When a pilot is uncertain of the clearance, ATC should be queried immediately as to what route of flight is preferred.

The name of an instrument approach, as published, is used to identify the approach, even if a component of the approach aid is inoperative or unreliable. The controller will use the name of the approach as published, but must advise the aircraft at the time an approach clearance is issued that the inoperative or unreliable approach aid component is unusable. (Example: “*Cleared ILS RWY 4, glide slope unusable.*”)

AREA NAVIGATION COURSES

RNAV (GPS) approach procedures introduce their own tracking issues because they are flown using an onboard navigation database. They may be flown as coupled approaches or flown manually. In either case, database coding directs the navigation system, including **waypoint (WP)** sequencing for the approach and missed approach. Database coding and/or hardware logic will indicate whether waypoints are fly-over or fly-by, and will provide appropriate guidance for each. A **fly-by (FB) waypoint** requires the use of turn anticipation to avoid overshooting the next flight segment. A **fly-over (FO) waypoint** precludes any turn until the waypoint is overflown, and is followed by either an intercept maneuver of the next flight segment or direct flight to the next waypoint.

Approach waypoints, except for the **missed approach waypoint (MAWP)** and the **missed approach holding waypoint (MAHWP)**, are normally fly-by waypoints. Notice that in the planview for figure 5-12 there are five fly-by waypoints, but only the circled waypoint

symbols at RW13 and SMITS are fly-over waypoints. If flying manually to a selected RNAV waypoint, pilots should anticipate the turn at a fly-by waypoint to ensure a smooth transition and avoid overshooting the next flight segment. Alternatively, for a fly-over waypoint, no turn is accomplished until the aircraft passes the waypoint.

There are circumstances when a waypoint may be coded into the database as both a FB WP and a FO WP, depending on how the waypoints are sequenced during the approach procedure. For example, a waypoint that serves as an IAF may be coded as a FB WP for the approach and as a FO WP when it also serves as the MAHWP for the missed approach procedure.

ALTITUDES

Prescribed altitudes may be depicted in four different configurations: minimum, maximum, recommended, and mandatory. The U.S. Government distributes approach charts produced by the National Imagery and Mapping Agency (NIMA) and NACO. Altitudes are depicted on these charts in the profile view with underscore, overscore, or both to identify them as minimum, maximum, or mandatory, respectively.

- Minimum altitudes are depicted with the altitude value underscored. Aircraft are required to maintain altitude at or above the depicted value.
- Maximum altitudes are depicted with the altitude value overscored. Aircraft are required to maintain altitude at or below the depicted value.
- Mandatory altitudes are depicted with the altitude value both underscored and overscored. Aircraft are required to maintain altitude at the depicted value.
- Recommended altitudes are depicted without an underscore or overscore.

NOTE: The underscore and overscore used to identify mandatory altitudes and overscore to identify maximum altitudes are used almost exclusively by the National Imagery and Mapping Agency (NIMA) for military charts. Pilots are cautioned to adhere to altitudes as prescribed because, in certain instances, they may be used as the basis for vertical separation of aircraft by ATC. When a depicted altitude is specified in the ATC clearance, that altitude becomes mandatory as defined above.

MINIMUM SAFE ALTITUDE

Minimum safe altitudes (MSAs) are published for emergency use on IAP charts. For conventional navigation systems, the MSA is normally based on the primary omnidirectional facility on which the IAP is predicated. The MSA depiction on the approach chart

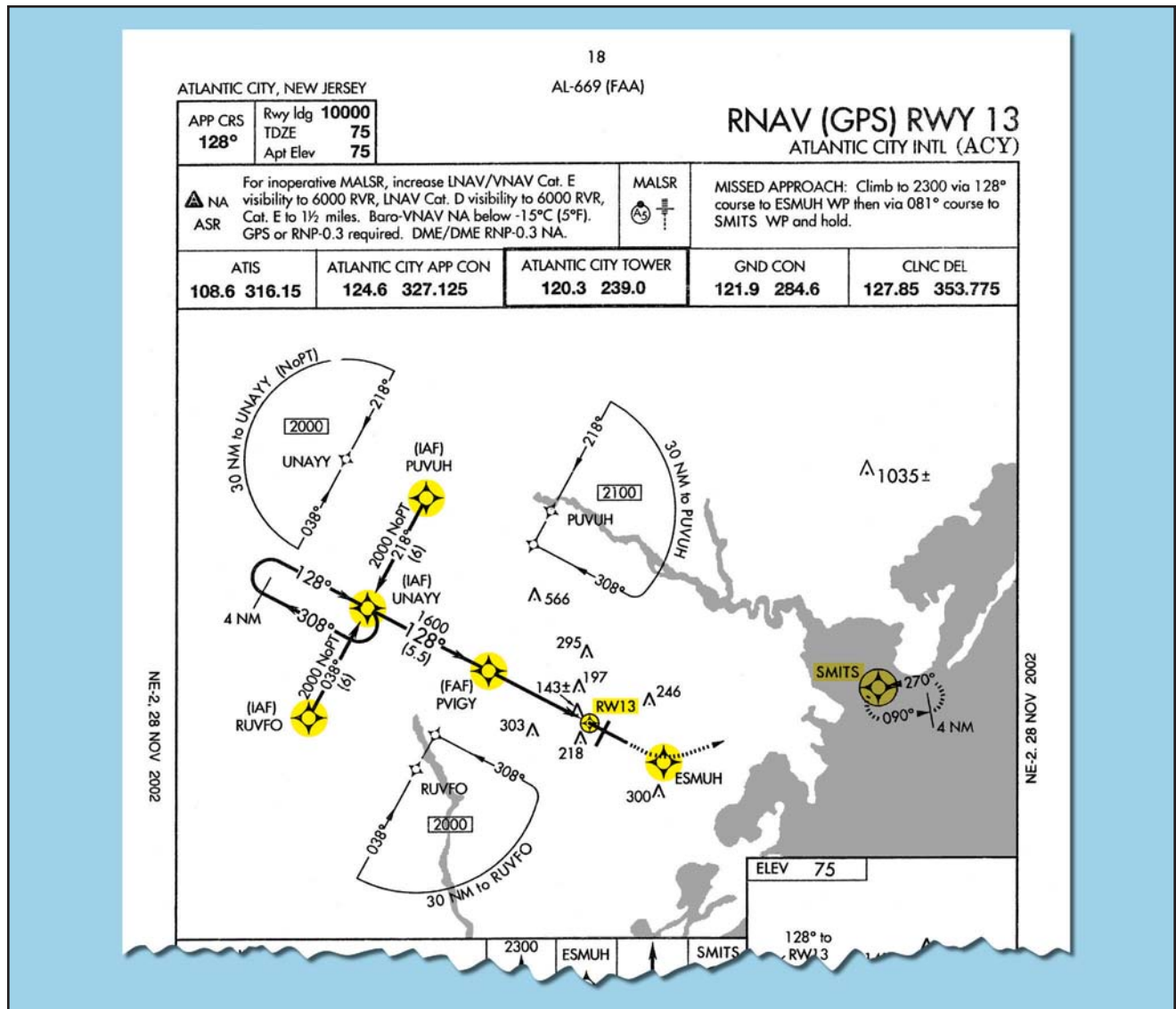

Figure 5-12. Fly-over and Fly-by Waypoints.

contains the facility identifier of the NAVAID used to determine the MSA. For RNAV approaches, the MSA is based on either the runway waypoint (RWY WP) or the missed approach waypoint (MAWP) for straight-in approaches, or the airport waypoint (APT WP) for circling only approaches. For RNAV (GPS) approaches with a terminal arrival area (TAA) the MSA is based on the IAF waypoint.

MSAs are expressed in feet above MSL and normally have a 25 NM radius. This radius may be expanded to 30 NM if necessary to encompass the airport landing surfaces. Ideally, a single sector altitude is established and depicted on the planview of approach charts. When necessary to maintain clearance from obstructions, the area may be further sectorized and as many as four MSAs established. When established, sectors may be no less than 90° in spread. MSAs provide 1,000 feet clearance over all obstructions but do not necessarily assure acceptable navigation signal coverage.

FINAL APPROACH FIX ALTITUDE

Another important altitude that should be briefed during an IAP briefing is the FAF altitude, designated by the cross on a nonprecision approach, and the lightning bolt symbol designating the glide slope intercept altitude on a precision approach. Adherence to and crosscheck of this altitude can have a direct effect on the success of an approach.

Proper airspeed, altitude, and configuration, when crossing the FAF of a nonprecision approach, are extremely important no matter what type of aircraft is being flown. The stabilized approach concept, implemented by the FAA within the SOPs of each air carrier, suggests that crossing the FAF at the published altitude is often a critical component of a successful non-precision approach, especially in a large turbojet aircraft.

The glide slope intercept altitude of a precision approach should also be included in the IAP briefing.

Awareness of this altitude when intercepting the glide slope can ensure the flight crew that a “false glide slope” or other erroneous indication is not inadvertently followed. Many air carriers include a standard callout when the aircraft passes over the FAF of the nonprecision approach underlying the ILS. The PNF states the name of the fix and the charted glide slope altitude, thus allowing both pilots to crosscheck their respective altimeters and verify the correct indications.

MINIMUM DESCENT ALTITUDE, DECISION ALTITUDE, AND DECISION HEIGHT

DA is currently used on RNAV approach charts with vertical descent guidance. DA will replace DH for Category I precision IAPs. MDA and DA are referenced to MSL and measured with a barometric altimeter. CAT II and III approach DHs are referenced to AGL and measured with a radio altimeter.

The height above touchdown (HAT) for a CAT I precision approach is normally 200 feet above touchdown zone elevation (TDZE). When a HAT of 250 feet or higher is published, it may be the result of the signal-in-space coverage, or there may be penetrations of either the final or missed approach obstacle clearance surfaces (OCS). If there are OCS penetrations, the pilot will have no indication on the approach chart where the obstacles are located. It is important for pilots to brief the MDA, DA or DH so that there is no ambiguity as to what minimums are being used. These altitudes can be restricted by many factors. Approach category, inoperative equipment in the aircraft or on the ground, crew qualifications, and company authorizations are all examples of issues that may limit or change the height of a published MDA, DA, or DH.

The primary authorization for the use of specific approach minimums by an individual air carrier can be found in Part C—Airplane Terminal Instrument Procedures, Airport Authorizations and Limitations, of its FAA approved OpsSpecs. This document lists the lowest authorized landing minimums that the carrier can use while conducting instrument approaches. Figure 5-13 shows an example of a carrier’s OpsSpecs that lists minimum authorized MDAs and visibilities for nonprecision approaches.

As can be seen from the previous example, the OpsSpecs of this company rarely restrict it from using the published MDA for a nonprecision approach. In other words, most, if not all, nonprecision approaches that pilots for this company fly have published MDAs that meet or exceed its lowest authorized minimums. Therefore the published minimums are the limiting factor in these cases.

For many air carriers, OpsSpecs may be the limiting factor for some types of approaches. NDB and circling approaches are two common examples where the OpsSpecs minimum listed altitudes may be more restrictive than the published minimums. Many Part 121 and 135 operators are restricted from conducting circling approaches below 1,000-foot MDA and 3 SM visibility by Part C of their OpsSpecs, and many have specific visibility criteria listed for NDB approaches that exceed visibilities published for the approach (commonly 2 SM). In these cases, flight crews must determine which is the more restrictive of the two and comply with those minimums.

In some cases, flight crew qualifications can be the limiting factor for the MDA, DA, or DH for an instrument approach. There are many CAT II and III approach procedures authorized at airports throughout the U.S., but special aircraft and aircrew requirements (SAAR) restrict their use to pilots who have received specific training, and aircraft that are equipped and authorized to conduct those approaches. Other rules pertaining to flight crew qualifications can also determine the lowest usable MDA, DA, or DH for a specific approach. Parts 121.652, 125.379, and 135.225 require that some pilots-in-command, with limited experience in the aircraft they are operating, increase the approach minimums and visibility by 100 feet and one-half mile respectively. Rules for these “high-minimums” pilots are usually derived from a combination of federal regulations and the company’s OpsSpecs. There are many factors that can determine the actual minimums that can be used for a specific approach. All of them must be considered by pilots during the preflight and approach planning phases, discussed, and briefed appropriately.

VERTICAL NAVIGATION

GPS and multi-sensor FMS have enabled many Part 121, 125, and 135 air carriers and Part 91 flight departments to conduct instrument approaches without having to rely solely on conventional forms of navigation. One of the advantages realized by commercial operators is the VNAV capability of some RNAV equipment. Traditionally, the only way to get glidepath information during an approach was to use a ground-based precision NAVAID. Modern RNAV equipment allows flight crews to display an electronically generated descent path that provides a constant-rate descent to minimums during approaches that would otherwise require multiple level-offs at stepdown fixes or manually calculating rates of descent. The pilots, airplane, and operator must be certified to use VNAV inside the FAF on an instrument approach. Flight crews

Straight-In Category I Approach Procedures Other Than ILS, MLS, or GPS and IFR Landing Minimums - All Airports

paragraph C53

The certificate holder shall not use any IFR Category I landing minimum lower than that prescribed by the applicable published instrument approach procedure. The IFR landing minimums prescribed in this paragraph are the lowest Category I minimums authorized for use at any airport.

- a. Category Approach Procedures Other Than ILS, MLS, or GLS. The certificate holder shall not use an IFR landing minimum for straight-in nonprecision approach procedures, lower than that specified in the following table. Touchdown Zone (TDZ) RVR reports, when available for a particular runway, are controlling for all approaches to and landings on that runway. (See note 6.)

Straight-In Category I Approach (Approaches other than ILS, MLS, or GPS Landing System (GLS))					
Approach Light Configuration	HAT (See notes 1, 2, & 3)	Aircraft Category A, B, and C		Aircraft Category D	
		Visibility In Statute Miles	TDZ RVR In Feet	Visibility In Statute Miles	TDZ RVR In Feet
No Lights	250	1	5000	1	5000
ODALS or MALS or SALS	250	3/4	4000	1	5000
	250	5/8	3000	1 (See NOTE 5)	5000 (See NOTES 5 & 6)
MALSR or SSALR or ALSF-1 or ALSF-2	250	1/2 (See NOTE 4)	2400 (See NOTES 4 & 6)	1 (See NOTE 5)	5000 (See NOTES 5 & 6)
DME ARC, Final Approach Segment, any light configuration	500	1	5000	1	5000

Note 1: For NDB approaches with a FAF, add 50 ft. to the HAT.

Note 2: For NDB approaches without a FAF, add 100 ft. to the HAT.

Note 3: For VOR approaches without a FAF, add 50 ft. to the HAT.

Note 4: For NDB approaches, the lowest authorized visibility is 3/4 and the lowest RVR is RVR 4000.

Note 5: For LOC approaches, the lowest authorized visibility is 3/4 and the lowest RVR is RVR 4000.

Note 6: The Mid RVR and Rollout RVR reports (if available) provide advisory information to pilots. The Mid RVR report may be substituted for the TDZ RVR report if the TDZ RVR report is not available.

Figure 5-13. Authorized Landing Minimums for Nonprecision Approaches.

intending to use the VNAV capabilities of airborne navigation systems during an instrument approach should include the pertinent VNAV information in their IAP briefing.

VNAV information appears on selected conventional nonprecision, GPS, and RNAV approaches (see Types of Approaches later in this chapter). It normally consists of two fixes (the FAF and the landing runway

threshold), a FAF crossing altitude, a fixed descent angle, and also may provide a visual descent point (VDP). Figure 5-14 shows how this information is displayed on the approach chart.

During a conventional nonprecision approach, this information can be used to provide a constant angle descent from the FAF crossing altitude to the runway threshold. Of course, descent below the MDA is only authorized when the appropriate weather conditions and visible references exist at the point on the glidepath that the aircraft reaches the MDA. If those conditions do not exist, pilots must level the aircraft at the MDA and proceed along the course until those conditions are met, or until the MAP is reached. Some RNAV equipment allows the use of a VNAV DA in lieu of the MDA, which can allow a lower minimum altitude. Operators of these aircraft would commence a missed approach immediately upon reaching the VNAV DA if the proper visibility does not exist.

A constant-rate descent has many safety advantages over the traditional method of descent on nonprecision approaches. A stabilized approach can be maintained from the FAF to the landing when a constant-rate descent is used. Additionally, the use of an electronic glide slope produced by onboard avionics can serve as a backup for terrain clearance, and can help to minimize the effects of visual illusions on approach and landing.

WIDE AREA AUGMENTATION SYSTEM

In addition to the benefits that VNAV information provides for conventional nonprecision approaches,

VNAV has a significant effect on approaches that are designed specifically for RNAV systems. Using an FMS or GPS that can provide both lateral navigation (LNAV) and VNAV, some RNAV approaches allow descents to lower MDAs or DAs than when using LNAV alone. The introduction of the Wide Area Augmentation System (WAAS), which became operational on July 10, 2003, provides even lower minimums for RNAV approaches that use GPS by providing electronic vertical guidance and increased accuracy.

The Wide Area Augmentation System, as its name implies, augments the basic GPS satellite constellation with additional ground stations and enhanced position integrity information transmitted from geostationary satellites. This capability of augmentation enhances both the accuracy and integrity of basic GPS, and may support electronic vertical guidance approach minimums as low as 250 feet HAT and 1/2 SM visibility. In order to achieve the lowest minimums, the requirements of an entire electronic vertical guidance system, including satellite availability; clear obstruction surfaces; AC 150/5300-13, *Airport Design*; and electronic vertical guidance runway and airport requirements, must be satisfied. The minimums are shown as DAs since electronically computed glidepath guidance is provided to the pilot. The electronically computed guidance eliminates errors that can be introduced when using barometric altimetry.

RNAV (GPS) approach charts may have as many as four lines of approach minimums: GLS or LPV,

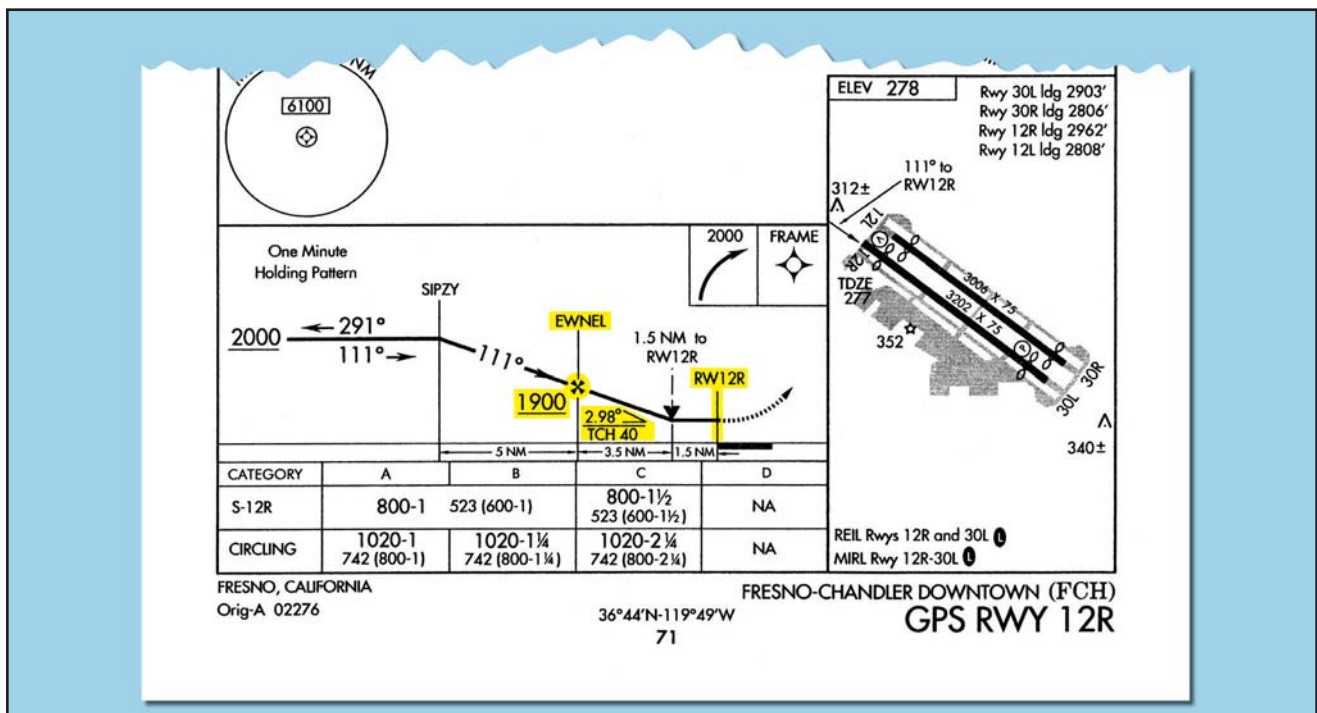

Figure 5-14. VNAV Information.

LNAV/VNAV, LNAV, and Circling. Figure 5-15 shows how these minimums may be presented on an approach chart, with the exception of GLS. See figure 5-16 on page 5-23 for an example of an approach that has GLS Precision Approach (PA) DA minimums. Note that the minimums show NA. This is because precision approaches using GPS are not yet available. This line will be replaced with LPV as new RNAV (GPS) approaches are designed.

- GLS (Global Navigation Satellite System [GNSS] Landing System) — the LPV minimums line will replace the current GLS PA DA – NA minimums line until a final decision is made regarding GLS precision approaches. In the future these approaches will possibly be published on separate charts.
- **LPV** — APV minimums that take advantage of WAAS to provide electronic vertical guidance

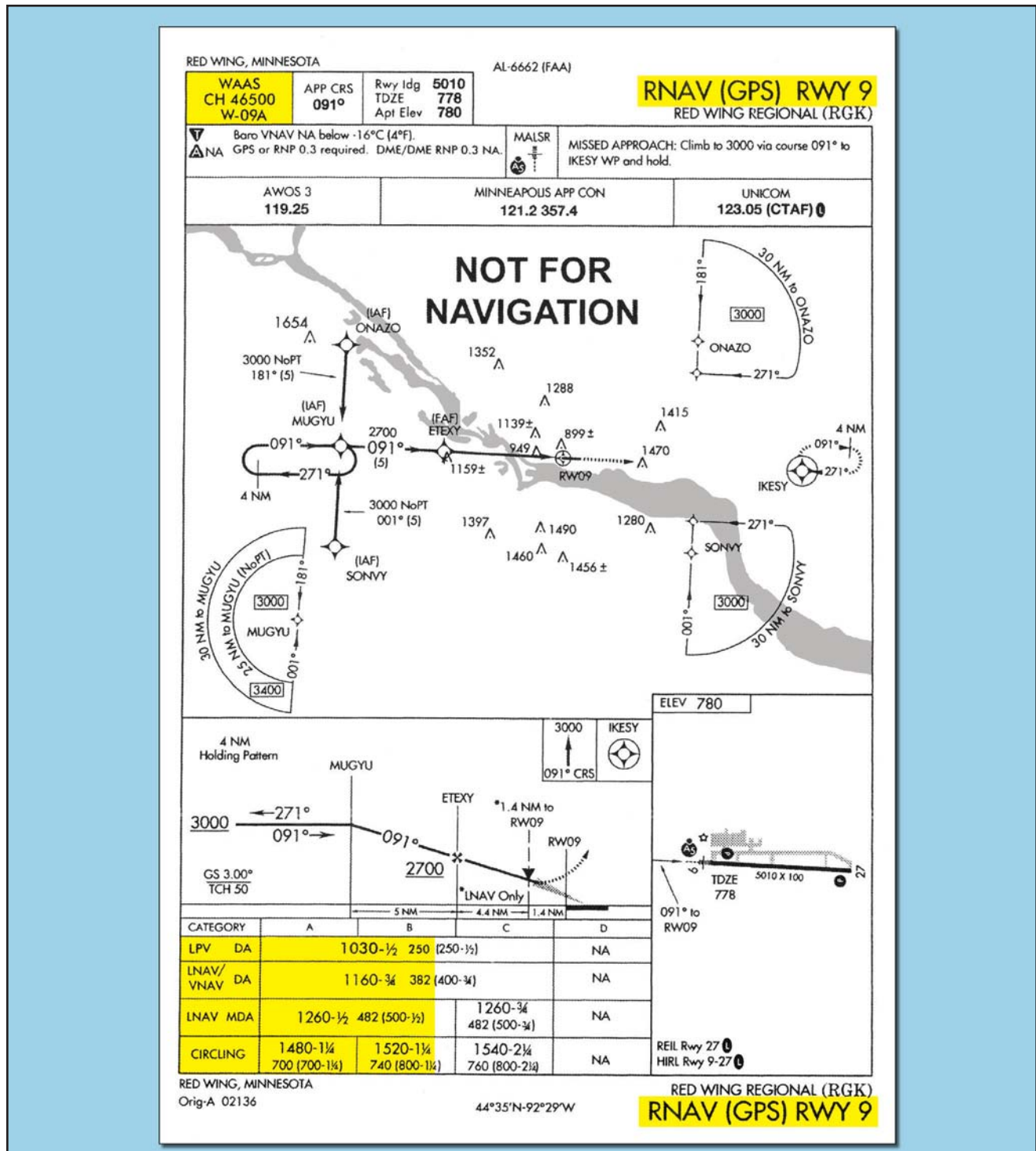

Figure 5-15. RNAV (GPS) Electronic Vertical Guidance Approach Minima.

capability. LPV is not an acronym. The name LPV is used for approaches constructed with WAAS criteria where the value for the vertical alarm limit is more than 12 meters and less than 50 meters. WAAS avionics equipment approved for LPV approaches is required for this type of approach. Notice the WAAS information shown in the top, left corner of the pilot briefing information on the chart depicted. Below the term WAAS is the WAAS channel number (CH 46500), and the WAAS approach identifier (W-09A), indicating Runway 9 in this case, and then a letter to designate the first in a series of procedures to that runway. Refer to the AIM for more information on WAAS flight procedures.

- LNAV/VNAV — APV minimums used by aircraft with RNAV equipment that provides both lateral and vertical information in the approach environment, including WAAS avionics approved for LNAV/VNAV approaches, certified barometric-VNAV (Baro-VNAV) systems with an IFR approach approved GPS, certified Baro-VNAV systems with an IFR approach approved WAAS system, or approach certified RNP 0.3 systems. Minimums are shown as DAs because the approaches are flown using an electronic glidepath. Other RNAV systems require special approval.
- LNAV — minimums provided for RNAV systems that do not produce any VNAV information. IFR approach approved GPS, WAAS, or RNP 0.3 systems are required. Because vertical guidance is not provided, the procedure minimum altitude is published as an MDA. These minimums are used in the same manner as conventional nonprecision approach minimums. Other RNAV systems require special approval.
- Circling — minimums that may be used with any type of approach approved RNAV equipment when publication of straight-in approach minimums is not possible.

RNAV APPROACH AUTHORIZATION

Like any other authorization given to air carriers and Part 91 operators, the authorization to use VNAV on a conventional nonprecision approach, RNAV approaches, or LNAV/VNAV approaches is found in that operator's OpsSpecs, AFM, or other FAA approved document. There are many different levels of authorizations when it comes to the use of RNAV approach systems. The type of equipment installed in the aircraft, the redundancy of that equipment, its operational status, the level of flight crew training, and the level of the operator's FAA authorization are all factors that can affect a

pilot's ability to use VNAV information on an approach.

Because most Part 121, 125, 135, and 91 flight departments include RNAV approach information in their pilot training programs, a flight crew considering an approach to North Platte, Nebraska, using the RNAV (GPS) RWY 30 approach shown in figure 5-16, would already know which minimums they were authorized to use. The company's OpsSpecs, Flight Operations Manual, and the AFM for the pilot's aircraft would dictate the specific operational conditions and procedures by which this type of approach could be flown.

There are several items of note that are specific to this type of approach that should be considered and briefed. One is the **terminal arrival area (TAA)** that is displayed in the approach planview. TAAs, discussed later in this chapter, depict the boundaries of specific arrival areas, and the MIA for those areas. The TAAs should be included in an IAP briefing in the same manner as any other IFR transition altitude. It is also important to note that the altitudes listed in the TAAs should be referenced in place of the MSAs on the approach chart for use in emergency situations.

In addition to the obvious differences contained in the planview of the previous RNAV (GPS) approach procedure example, pilots should be aware of the issues related to Baro-VNAV and RNP. The notes section of the procedure in the example contains restrictions relating to these topics.

Baro-VNAV is a navigational system that presents computed vertical guidance to the pilot referenced to a specified vertical path angle (VPA). The computer calculated vertical guidance is based on barometric altitude, and is either computed as a geometric path between two waypoints or an angle from a single waypoint. If a flight crew is authorized to conduct VNAV approaches using an RNAV system that falls into this category, the Baro-VNAV temperature limitations listed in the notes section of the approach procedure apply.

Considering the pronounced effect of cold temperatures on Baro-VNAV operations, a minimum temperature limitation is published for each procedure for which Baro-VNAV minimums are published. This temperature represents the airport temperature below which the use of Baro-VNAV is not authorized to the LNAV/VNAV DA. The note "Baro-VNAV NA below -20°C (-5°F)" implies that the approach may not be flown at all using Baro-VNAV when the temperature is below -20° Celsius. However, Baro-VNAV may be used for approach guidance down to the published LNAV MDA. This information can be seen in the notes section of the previous example.

The lowest level of sensors that the FAA will authorize for RNP 0.3 navigation is DME/DME. The necessary DME NAVAID ground infrastructure may or may not be available at the airport of intended landing. Where FAA Flight Inspection successfully determines that the coverage and accuracy of DME facilities support RNP 0.3, and that the DME signal meets inspection tolerances, a note such as “DME/DME RNP 0.3 Authorized” appears on the chart. The procedures designer also has a computer program for determining the usability of DME based on geometry and coverage. Flight Inspection records coverage and accuracy and checks for co-channel interference and forwards the result to Flight Standards for approval. Where DME facility availability is a factor, the note may read “DME/DME RNP 0.3 Authorized; ABC and XYZ required,” meaning that ABC and XYZ DME facilities are required to assure RNP 0.3.

AIRPORT/RUNWAY INFORMATION

Another important piece of a thorough approach briefing is the discussion of the airport and runway environment. A detailed examination of the runway distance available, the intended turnoff taxiway, and the route of taxi to the parking area, are all important safety enhancing briefing items. In addition, runway conditions should be discussed. The effect on the aircraft’s performance must be considered if the runway is wet or contaminated.

NACO approach charts include a runway sketch on each approach chart to make important airport information easily accessible to pilots. In addition, at airports that have complex runway/taxiway configurations, a separate full-page airport diagram will be published. The airport diagram also includes the latitude/longitude information required for initial programming of FMS equipment. The included latitude/longitude grid shows the specific location of each parking area on the airport surface for use in initializing FMSs. Figure 5-17 shows the airport sketch and diagram for Chicago-O’Hare International Airport.

Pilots making approaches to airports that have this type of complex runway and taxiway configuration must ensure that they are familiar with the airport diagram prior to initiating an instrument approach. A combination of poor weather, high traffic volume, and high ground controller workload makes the pilot’s job on the ground every bit as critical as the one just performed in the air.

INSTRUMENT APPROACH PROCEDURE BRIEFING

A thorough instrument approach briefing greatly increases the likelihood of a successful instrument approach. Most Part 121, 125, and 135 operators designate specific items to be included in an IAP briefing, as well as the order in which those items will be briefed.

Before an IAP briefing can begin, flight crews must decide which procedure is most likely to be flown from the information that is available to them. Most often, when the flight is being conducted into an airport that has ATIS information, the ATIS will provide the pilots with the approaches that are in use. If more than one approach is in use, the flight crew may have to make an educated guess as to which approach will be issued to them based on the weather, direction of their arrival into the area, any published airport NOTAMs, and previous experience at the specific airport. If the crew is in contact with the approach control facility, they can query ATC as to which approach is to be expected from the controller. Pilots may request specific approaches to meet the individual needs of their equipment or regulatory restrictions at any time and ATC will, in most cases, be able to accommodate those requests, providing that workload and traffic permit.

If the flight is operating into an airport without a control tower, the flight crew will occasionally be given the choice of any available instrument approach at the field. In these cases, the flight crew must choose an appropriate approach based on the expected weather, aircraft performance, direction of arrival, airport NOTAMs, and previous experience at the airport.

NAVIGATION AND COMMUNICATION RADIOS

Once the anticipated approach and runway have been selected, each crewmember sets up their “side” of the cockpit. The pilots use information gathered from ATIS, dispatch (if available), ATC, the specific approach chart for the approach selected, and any other sources that are available. Company regulations dictate how certain things are set up and others are left up to pilot technique. In general, the techniques used at a specific company are similar. This section addresses two-pilot operations. During single-pilot IFR flights, the same items must be set up and the pilot should still do an approach briefing to verify that everything is set up correctly.

The number of items that can be set up ahead of time depends on the level of automation of the aircraft and the avionics available. In a conventional cockpit, the only things that can be set up, in general, are the airspeed bugs (based on performance calculations), altimeter bug (to DA, DH, or MDA), go around thrust/power setting, the radio altimeter bug (if installed and needed for the approach), and the navigation/communication radios (if a standby frequency selector is available). The standby side of the PF navigation radio should be set to the primary NAVAID for the approach and the PNF navigation radio standby selector should be set to any other NAVAIDs that are required or available, and as dictated by company procedures, to add to the overall situational awareness of the crew. The

03023

AIRPORT DIAGRAM

AL-166 (FAA)

CHICAGO-O'HARE INTL (ORD)
CHICAGO, ILLINOIS

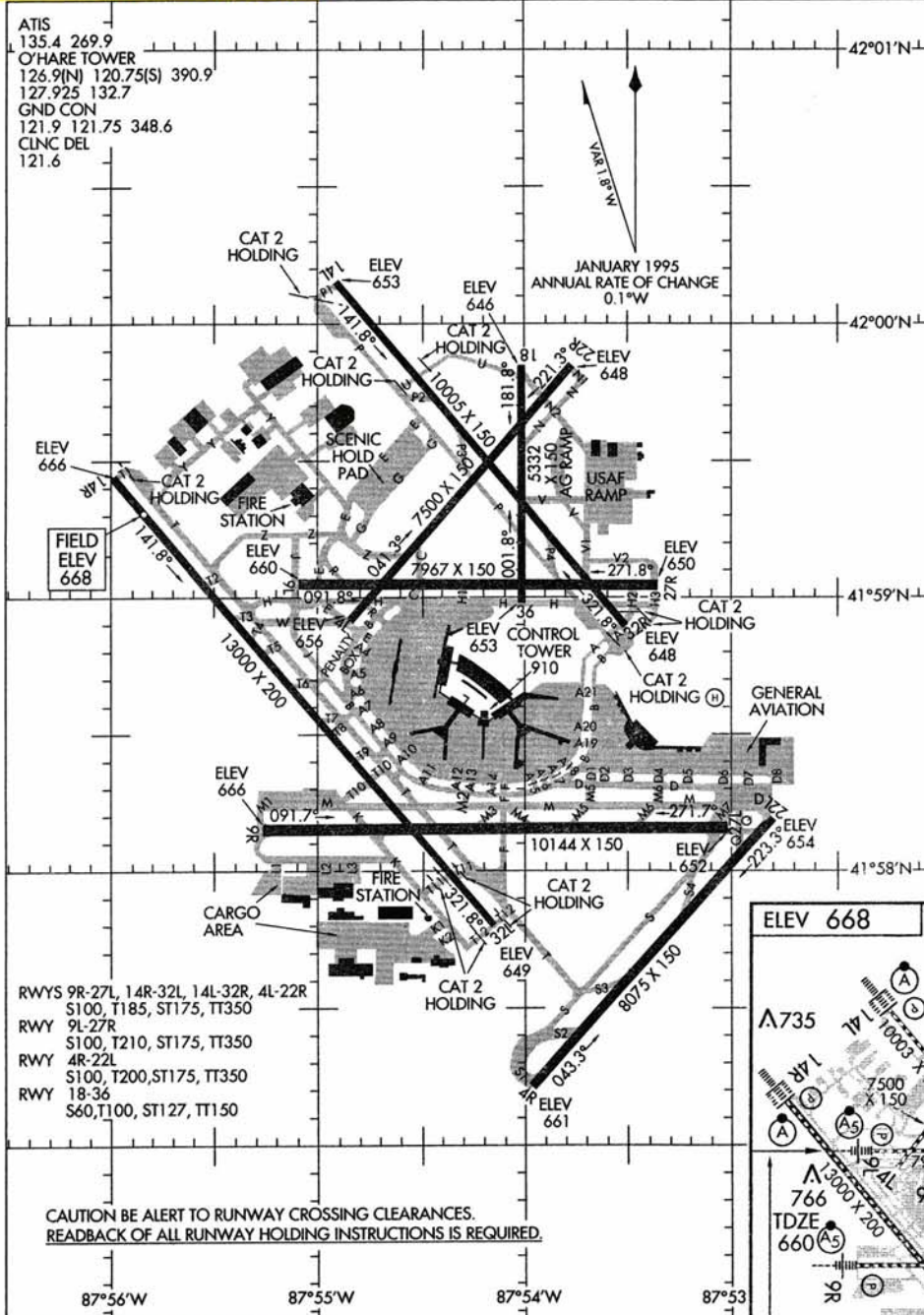

EC-3, 23 JAN 2003

EC-3, 23 JAN 2003

AIRPORT DIAGRAM

03023

157

CHICAGO-

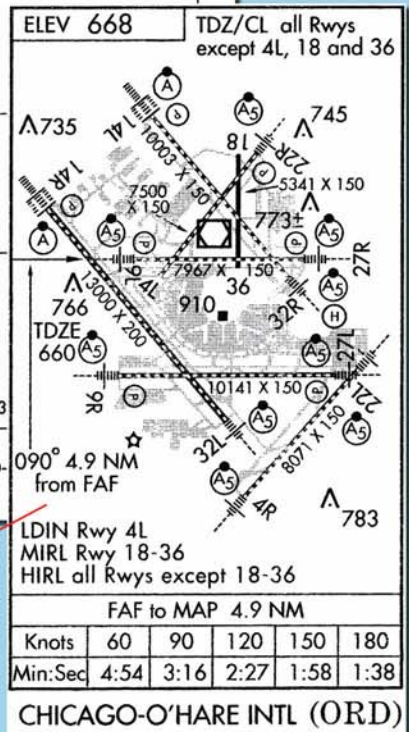

Airport Sketch

Figure 5-17. Airport Sketch and Diagram for Chicago-O'Hare International.

automatic direction finder (ADF) should also be tuned to an appropriate frequency as required by the approach, or as selected by the crew.

FLIGHT MANAGEMENT SYSTEMS

In addition to the items that are available on a conventional cockpit aircraft, glass-cockpit aircraft, as well as aircraft with an approved RNAV (GPS) system, usually give the crew the ability to set the final approach course for the approach selected and many other options to increase situational awareness. Crews of FMS equipped aircraft have many options available as far as setting up the flight management computer (FMC), depending on the type of approach and company procedures. The PF usually programs the FMC for the approach and the PNF verifies the information. A menu of available approaches is usually available to select from based on the destination airport programmed at the beginning of the flight or a new destination selected while en route.

The amount of information provided for the approach varies from aircraft to aircraft, but the crew can make modifications if something is not pre-programmed into the computer, such as adding a missed approach procedure or even building an entire approach for situational awareness purposes. Usually this type of FMC programmed approach guidance is not certified as the primary source of navigation information for an instrument approach. The PF can also program a VNAV profile for the descent and LNAV for segments that were not programmed during preflight, such as a Standard Terminal Arrival Route (STAR) or expected route to the planned approach. Any crossing restrictions for the STAR might need to be programmed as well. The most common crossing restrictions, whether mandatory or “to be expected,” are usually automatically programmed when the STAR is selected, but can be changed by ATC at any time. Other items that need to be set up are dictated by aircraft-specific procedures, such as autopilot, auto-throttles, auto-brakes, pressurization system, fuel system, seat belt signs, anti-icing/de-icing equipment, igniters, etc.

AUTOPILOT MODES

In general, an autopilot can be used to fly approaches even if the FMC is inoperative (refer to the specific airplane’s minimum equipment list [MEL] to determine authorization for operating with the FMC inoperative). Whether or not the FMC is available, use of the autopilot should be discussed during the approach briefing, especially regarding the use of the altitude pre-selector and auto-throttles, if equipped. The AFM for the specific airplane outlines procedures and limitations required for the use of the

autopilot during an instrument approach in that aircraft.

There are just as many different autopilot modes to climb or descend the airplane as there are terms for these modes (ex. Level Change [LVL CHG], Vertical Speed [V/S], VNAV, Takeoff/Go Around [TO/GA], etc.). The pilot controls the airplane through the autopilot by selecting pitch modes and/or roll modes, as well as the associated auto-throttle modes. This panel, sometimes called a mode control panel, is normally accessible to both pilots. Most aircraft with sophisticated auto-flight systems and auto-throttles have the capability to select modes that climb the airplane with maximum climb thrust and descend the airplane with the throttles at idle (LVL CHG, Flight Level Change [FL CHG], Manage Level, etc.). They also have the capability to “capture,” or level off at pre-selected altitudes, as well as track a LOC and glide slope (G/S) or a VOR course. If the airplane is RNAV equipped, the autopilot will also track the RNAV generated course. Most of these modes will be used at some point during an instrument approach using the autopilot. Additionally, these modes can be used to provide flight director (FD) guidance to the pilot while hand-flying the aircraft.

For the purposes of this precision approach example, the auto-throttles are engaged when the autopilot is engaged and specific airspeed and configuration changes will not be discussed. The PF controls airspeed with the speed selector on the mode control panel and calls for flaps and landing gear as needed, which the PNF will select. The example in figure 5-18 begins with the airplane 5 NM northwest of BROWN at 4,500 feet with the autopilot engaged, and the flight has been cleared to track the Rwy 12 LOC inbound. The current roll mode is LOC with the PF’s NAV radio tuned to the LOC frequency of 109.3; and the current pitch mode is altitude hold (ALT HOLD). Approach control clears the airplane for the approach. The PF makes no immediate change to the autopilot mode to prevent the aircraft from capturing a false glide slope; but the PNF resets the altitude selector to 2,200 feet. The aircraft will remain level because the pitch mode remains in ALT HOLD until another pitch mode is selected. Upon reaching BROWN, the PF selects LVL CHG as the pitch mode. The auto-throttles retard to idle as the airplane begins a descent. Approaching 2,200 feet, the pitch mode automatically changes to altitude acquire (ALT ACQ) then to ALT HOLD as the airplane levels at 2,200 feet. In addition to slowing the airplane and calling for configuration changes, the PF selects approach mode (APP). The roll mode continues to track the LOC and the pitch

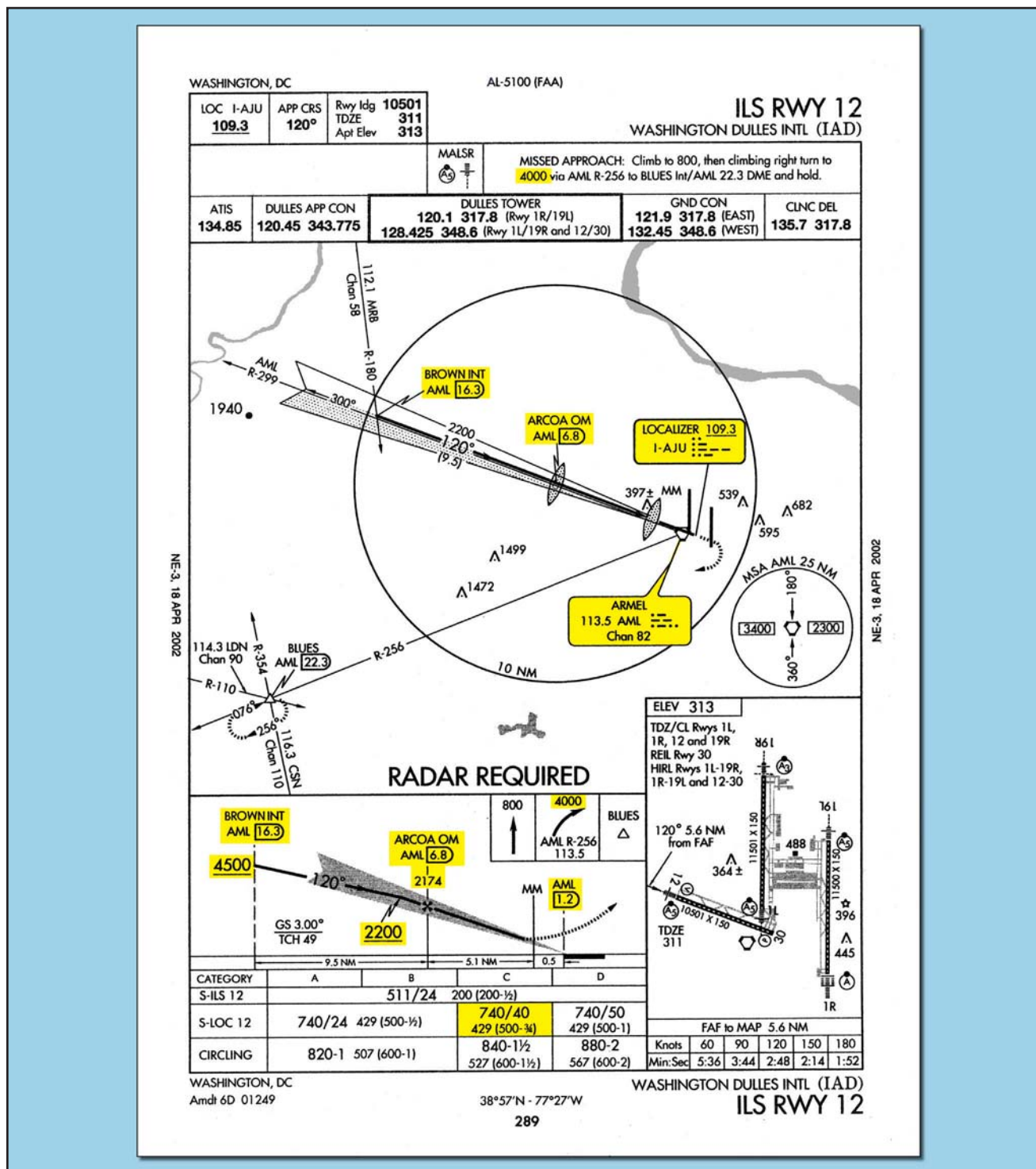

Figure 5-18. Example Approaches Using Autopilot.

mode remains in ALT HOLD; however, the G/S mode arms. Selecting APP once the aircraft has leveled at the FAF altitude is a suggested technique to ensure that the airplane captures the glide slope from below, and that a false glide slope is not being tracked.

The PF should have the aircraft fully configured for landing before intercepting the glide slope to ensure a

stabilized approach. As the airplane intercepts the glide slope, the pitch mode changes to G/S. Once the glide slope is “captured” by the autopilot, the PNF can select the missed approach altitude in the altitude pre-selector, as requested by the PF. The airplane will continue to track the glide slope. The minimum altitude at which the PF is authorized to disconnect the autopilot is airplane specific (Example, 50 feet below DA, DH, or MDA but not less than 50 feet AGL). The PF can

disconnect the autopilot at any time prior to reaching this altitude during a CAT I approach. The missed approach is hand flown with FD guidance unless a CAT III approach is being conducted in an airplane that is capable of flying a missed approach using the autopilot.

The differences when flying the underlying nonprecision approach begin when the aircraft has leveled off at 2,200 feet. Once ALT HOLD is annunciated the MDA is selected by the PNF as requested by the PF. **It is extremely important for both pilots to be absolutely sure that the correct altitude is selected for the MDA so that the airplane will not inadvertently descend below the MDA.** Because the altitude pre-selector can only select 100-foot increments, the MDA for this approach must be set at 800 feet instead of 740 feet.

Vertical speed mode is used from the FAF inbound to allow for more precise control of the descent. If the pilots had not selected the MDA in the altitude pre-selector window, the PF would not be able to input a V/S and the airplane would remain level. The autopilot mode will change from ALT ACQ to ALT HOLD as the airplane levels at 800 feet. Once ALT HOLD is annunciated, the PF calls for the missed approach altitude of 4,000 feet to be selected in the altitude pre-selector window. This step is very important because accurate FD guidance will not be available to the PF during a missed approach if the MDA is left in the window.

NOTE: See Maximum Acceptable Descent Rates under the heading Descent Rates and Glidepaths for Nonprecision Approaches below.

STABILIZED APPROACH

In instrument meteorological conditions (IMC), you must continuously evaluate instrument information throughout an approach to properly maneuver the aircraft (or monitor autopilot performance) and to decide on the proper course of action at the decision point (DA, DH, or MAP). Significant speed and configuration changes during an approach can seriously degrade situational awareness and complicate the decision of the proper action to take at the decision point. The swept wing handling characteristics at low airspeeds and slow engine-response of many turbojets further complicate pilot tasks during approach and landing operations. You must begin to form a decision concerning the probable success of an approach before reaching the decision point. Your decision-making process requires you to be able to determine displacements from the course or glide-path centerline, to mentally project the aircraft's

three-dimensional flight path by referring to flight instruments, and then apply control inputs as necessary to achieve and maintain the desired approach path. This process is simplified by maintaining a constant approach speed, descent rate, vertical flight path, and configuration during the final stages of an approach. This is referred to as the stabilized approach concept.

A stabilized approach is essential for safe turbojet operations and commercial turbojet operators must establish and use procedures that result in stabilized approaches. A stabilized approach is also strongly recommended for propeller-driven airplanes and helicopters. You should limit configuration changes at low altitudes to those changes that can be easily accommodated without adversely affecting your workload. For turbojets, the airplane must be in an approved configuration for landing or circling, if appropriate, with the engines spooled up, and on the correct speed and flight path with a descent rate of less than 1,000 FPM before descending below the following minimum stabilized approach heights:

- For all straight-in instrument approaches (this includes contact approaches) in IFR weather conditions, the approach must be stabilized before descending below 1,000 feet above the airport or TDZE.
- For visual approaches and straight-in instrument approaches in VFR weather conditions, the approach must be stabilized before descending below 500 feet above the airport elevation.
- For the final segment of a circling approach maneuver, the approach must be stabilized 500 feet above the airport elevation or at the MDA, whichever is lower.

These conditions must be maintained throughout the approach until touchdown for the approach to be considered a stabilized approach. This also helps you to recognize a windshear situation should abnormal indications exist during the approach.

DESCENT RATES AND GLIDEPATHS FOR NONPRECISION APPROACHES

Maximum Acceptable Descent Rates: Operational experience and research have shown that a descent rate of greater than approximately 1,000 FPM is unacceptable during the final stages of an approach (below 1,000 feet AGL). This is due to a human perceptual limitation that is independent of the type of airplane or helicopter. Therefore, the operational practices and techniques must ensure that descent rates greater than 1,000 FPM are not permitted in either the instrument or visual portions of an approach and landing operation.

For short runways, arriving at the MDA at the MAP when the MAP is located at the threshold may require a missed approach for some airplanes. For nonprecision approaches a descent rate should be used that will ensure that the airplane reaches the MDA at a distance from the threshold that will allow landing in the touchdown zone. To determine the required rate of descent, subtract the TDZE from the FAF altitude and divide this by the time inbound. For example if the FAF altitude is 2,000 feet MSL, the TDZE is 400 feet MSL and the time inbound is two minutes, an 800 FPM rate of descent should be used.

To verify the airplane is on an approximate 3° glidepath, use a calculation of “300-foot-to 1 NM.” The glidepath height above TDZE is calculated by multiplying the NM distance from the threshold by 300. For example, at 10 NM the aircraft should be 3,000 feet above the TDZE, at 5 NM 1,500 feet, at 2 NM 600 feet, at 1.5 NM 450 feet, etc., until a safe landing can be made. In the above example the aircraft should arrive at the MDA (800 feet MSL) approximately 1.3 NM from the threshold and in a position to land in the touchdown zone. Techniques for deriving a “300-to-1” glidepath include using distance measuring equipment (DME), distance advisories provided by radar-equipped control towers, RNAV (exclusive of Omega navigation systems), GPS, dead reckoning, and pilotage when familiar features on the approach course are visible. The runway threshold should be crossed at a nominal height of 50 feet above the TDZE.

TRANSITION TO VISUAL

The transition from instrument flight to visual flight during an instrument approach can be very challenging, especially during low visibility operations. Additionally, single-pilot operations make the transition even more challenging. Approaches with vertical guidance add to the safety of the transition to visual because the approach is already stabilized upon visually acquiring the required references for the runway. One hundred to 200 feet prior to reaching the DA, DH, or MDA, most of the PNF’s attention should be outside of the aircraft in order to visually acquire at least one visual reference for the runway, as required by the regulations. The PF should stay focused on the instruments until the PNF calls out any visual aids that can be seen, or states “*runway in sight.*” The PF should then begin the transition to visual flight. It is common practice for the PNF to call out the V/S during the transition to confirm to the PF that the instruments are being monitored, thus allowing more of the PF’s attention to be focused

on the visual portion of the approach and landing. Any deviations from the stabilized approach criteria should also be announced by the PNF.

Single-pilot operations can be much more challenging because the pilot must continue to fly by the instruments while attempting to acquire a visual reference for the runway. While it is important for both pilots of a two-pilot aircraft to divide their attention between the instruments and visual references, it is even more critical for the single-pilot operation. The flight visibility must also be at least the visibility minimum stated on the instrument approach chart, or as required by regulations. CAT II and III approaches have specific requirements that may differ from CAT I precision or nonprecision approach requirements regarding transition to visual and landing. This information can be found in the operator’s OpsSpecs or Flight Operations Manual.

The visibility published on an approach chart is dependent on many variables, including the height above touchdown for straight-in approaches, or height above airport elevation for circling approaches. Other factors include the approach light system coverage, and type of approach procedure, such as precision, nonprecision, circling or straight-in. Another factor determining the minimum visibility is the penetration of the 34:1 and 20:1 surfaces. These surfaces are inclined planes that begin 200 feet out from the runway and extend outward to 10,000 feet. If there is a penetration of the 34:1 surface, the published visibility can be no lower than 3/4 SM. If there is penetration of the 20:1 surface, the published visibility can be no lower than 1 SM with a note prohibiting approaches to the affected runway at night (both straight-in and circling). [Figure 5-19 on next page] Circling may be permitted at night if penetrating obstacles are marked and lighted. If the penetrating obstacles are not marked and lighted, a note is published that night circling is “Not Authorized.” Pilots should be aware of these penetrating obstacles when entering the visual and/or circling segments of an approach and take adequate precautions to avoid them.

MISSED APPROACH

Many reasons exist for executing a missed approach. The primary reason, of course, is that the required flight visibility prescribed in the IAP being used does not exist or the required visual references for the runway cannot be seen upon arrival at the DA, DH or MAP. In addition, according to Part 91, the aircraft must continuously be in a position from which a descent to a landing on the intended runway can be

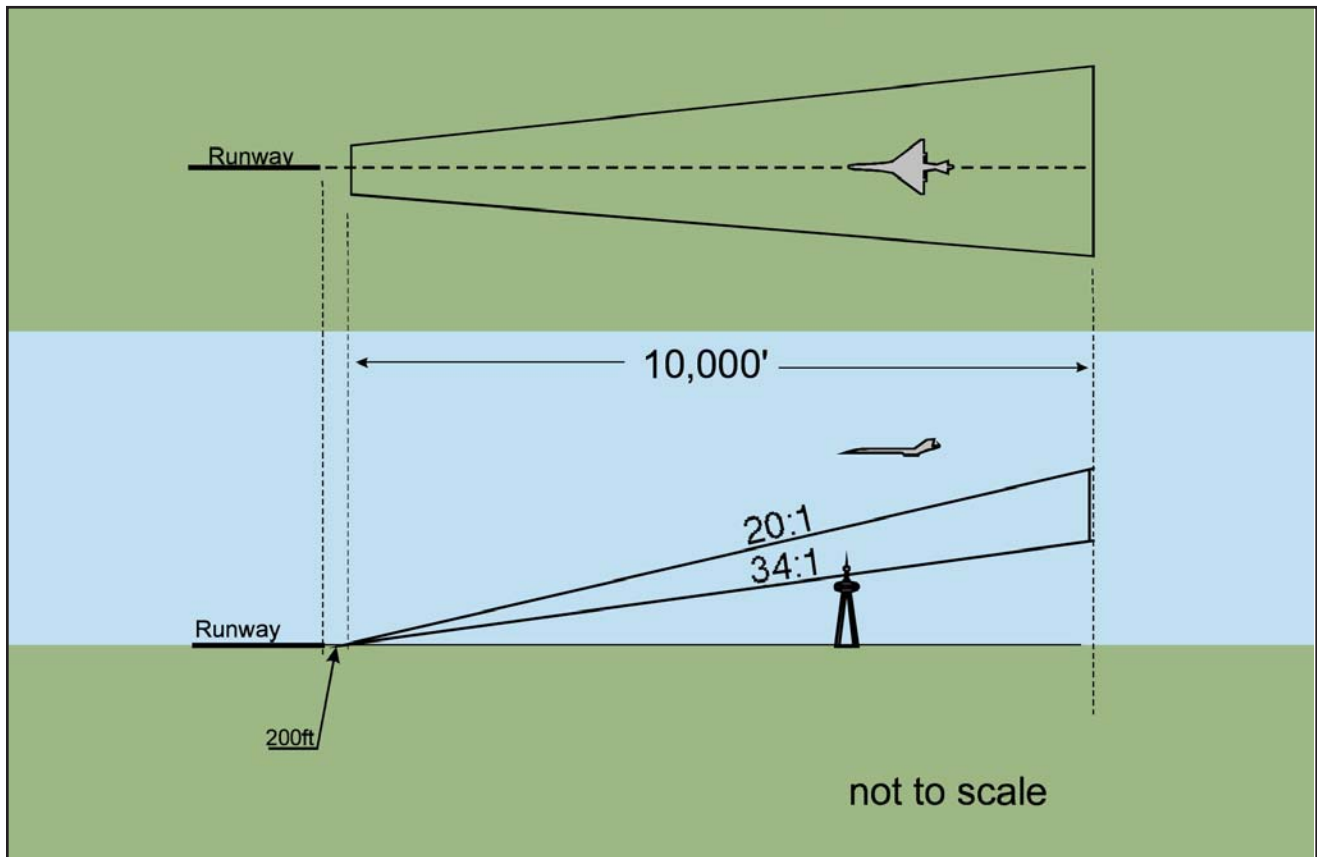

Figure 5-19. Determination of Visibility Minimums.

made at a normal rate of descent using normal maneuvers, and for operations conducted under Part 121 or 135, unless that descent rate will allow touchdown to occur within the touchdown zone of the runway of intended landing. [Figure 5-20] CAT II and III approaches call for different visibility requirements as prescribed by the Administrator.

Once descent below the DA, DH, or MDA is begun, a missed approach must be executed if the required visibility is lost or the runway environment is no longer visible, unless the loss of sight of the runway is a result of normal banking of the aircraft during a circling approach. A missed approach procedure is also required upon the execution of a rejected landing for any reason, such as men and equipment or animals on the runway, or if the approach becomes unstabilized and a normal landing cannot be performed. After the MAP in the visual segment of a nonprecision approach there may be hazards when executing a missed approach below the MDA. Any missed approach after a DA, DH, or MAP below the DA, DH, or MDA involves additional risk until established on the published missed approach procedure course and altitude.

91.175 TAKEOFF AND LANDING UNDER IFR

- (c) Operation below DH or MDA. Where a DH or MDA is applicable, no pilot may operate an aircraft, except a military aircraft of the United States, at any airport below the authorized MDA or continue an approach below the authorized DH unless —
- (1) The aircraft is continuously in a position from which a descent to a landing on the intended runway can be made at a normal rate of descent using normal maneuvers, and for operations conducted under Part 121 or Part 135 unless that descent rate will allow touchdown to occur within the touchdown zone of the runway of intended landing.
 - (2) The flight visibility is not less than the visibility prescribed in the standard instrument approach procedure being used; and
 - (3) Except for a Category II or Category III approach where any necessary visual reference requirements are specified by the Administrator, at least one of the following visual references for the intended runway is distinctly visible and identifiable to the pilot:
 - (i) The approach light system, except that the pilot may not descend below 100 feet above the touchdown zone elevation using the approach lights as a reference unless the red terminating bars or the red side row bars are also distinctly visible and identifiable.
 - (ii) The threshold.
 - (iii) The threshold markings.
 - (iv) The threshold lights.
 - (v) The runway end identifier lights.
 - (vi) The visual approach slope indicator.
 - (vii) The touchdown zone or touchdown zone markings.
 - (viii) The touchdown zone lights.
 - (ix) The runway or runway markings.
 - (x) The runway lights.

Figure 5-20. Operation Below DA, DH or MDA.

At airports with control towers it is common for ATC to assign alternate missed approach instructions; even so, pilots should always be prepared to fly the published missed approach. When a missed approach is executed prior to reaching the MAP, the pilot is required to continue along the final approach course, at an altitude above the DA, DH, or MDA, until reaching the MAP before making any turns. If a turn is initiated prior to the MAP, obstacle clearance is not guaranteed. It is appropriate after passing the FAF, and recommended, where there aren't any climb restrictions, to begin a climb to the missed approach altitude without waiting to arrive at the MAP. Figure 5-21 gives an example of an altitude restriction that would prevent a climb between the FAF and MAP. Note in the example, if a missed approach is initiated prior to reaching the 3 DME fix, a descent to 1,160 feet is required before climbing to 1,200 feet. Pilot Briefing Information

charts, in addition to the missed approach text in the second line of the chart, indicate the initial vertical and lateral missed approach guidance as icons in the profile view.

The missed approach course begins at the MAP and continues until the aircraft has reached the designated fix and a holding pattern has been entered, unless there is no holding pattern published for the missed approach. It is common at large airports with high traffic volume to not have a holding pattern depicted at the designated fix. [Figure 5-22 on the next page] In these circumstances, the departure controller will issue further instructions before the aircraft reaches the final fix of the missed approach course. It is also common for the designated fix to be an IAF so that another approach attempt can be made without having to fly from the holding fix to an IAF.

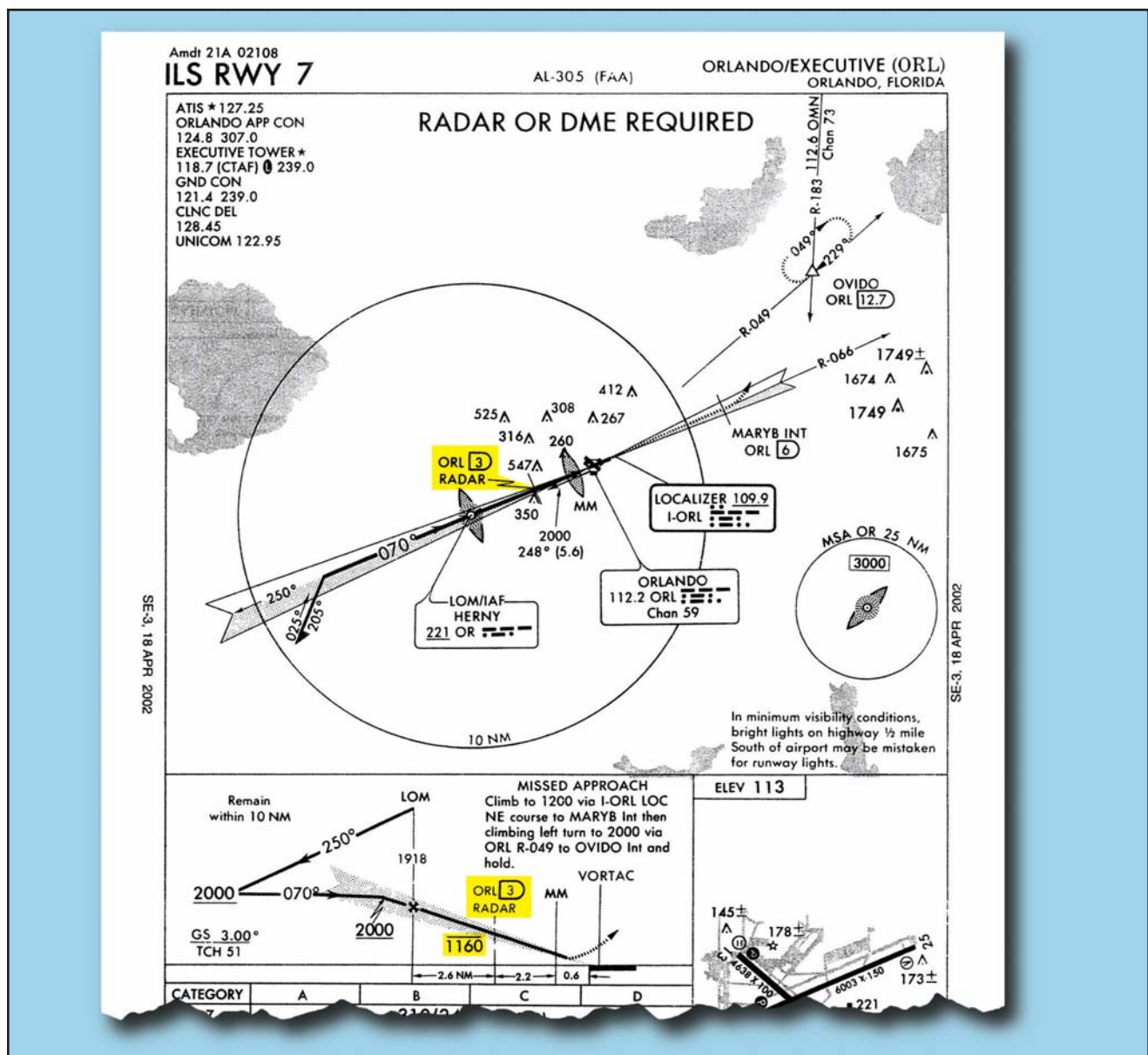

Figure 5-21. Orlando Executive Airport, Orlando, Florida, ILS RWY 7.

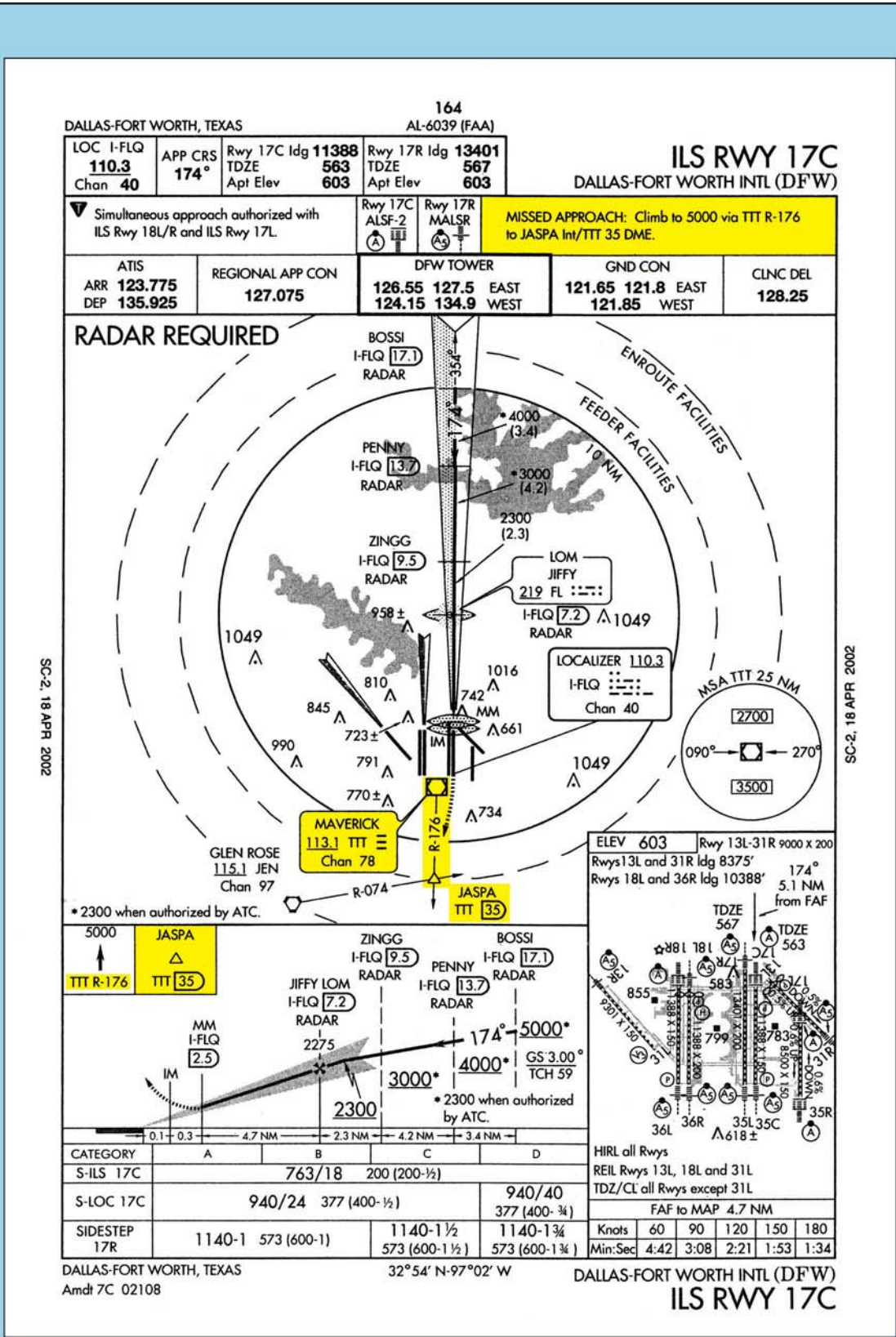

Figure 5-22. Missed Approach Procedure without Holding Pattern.

As shown in figure 5-23, there are many different ways that the MAP can be depicted, depending on the type of approach. On all approach charts it is depicted in the profile and planviews by the end of the solid course line and the beginning of the dotted missed approach course line. For a precision approach, the MAP is the point at which the aircraft reaches the DA or DH while on the glide slope. MAPs on nonprecision approaches can be determined in many different ways. If the primary NAVAID is on the airport, the MAP is normally the point at which the aircraft passes the NAVAID.

On some nonprecision approaches, the MAP is given as a time from the FAF to the runway threshold based on the groundspeed of the aircraft. A table on the lower right hand side of the approach chart shows the distance in NM from the FAF to the MAP and the time it takes at specific groundspeeds, given in 30-knot increments. Pilots must determine the approximate groundspeed and time based on the approach speed and true airspeed of their aircraft and the current winds along the final approach course. A clock or stopwatch should be started at the FAF of an approach requiring this method. Many approaches designate a specific fix as the

MAP. These can be identified by a course (LOC or VOR) and DME, a cross radial from a VOR, or an RNAV (GPS) waypoint.

EXAMPLE APPROACH BRIEFING

During an instrument approach briefing, the name of the airport and the specific approach procedure should be identified to allow other crewmembers the opportunity to cross-reference the chart being used for the brief. This ensures that pilots intending to conduct an instrument approach have collectively reviewed and verified the information pertinent to the approach. Figure 5-24 on the next page gives an example of the items to be briefed and their sequence. Although the following example is based on multi-crew aircraft, the process is also applicable to single-pilot operations. A complete instrument approach and operational briefing example follows.

The approach briefing begins with a general discussion of the ATIS information, weather, terrain, NOTAMs, approaches in use, runway conditions, performance considerations, expected route to the

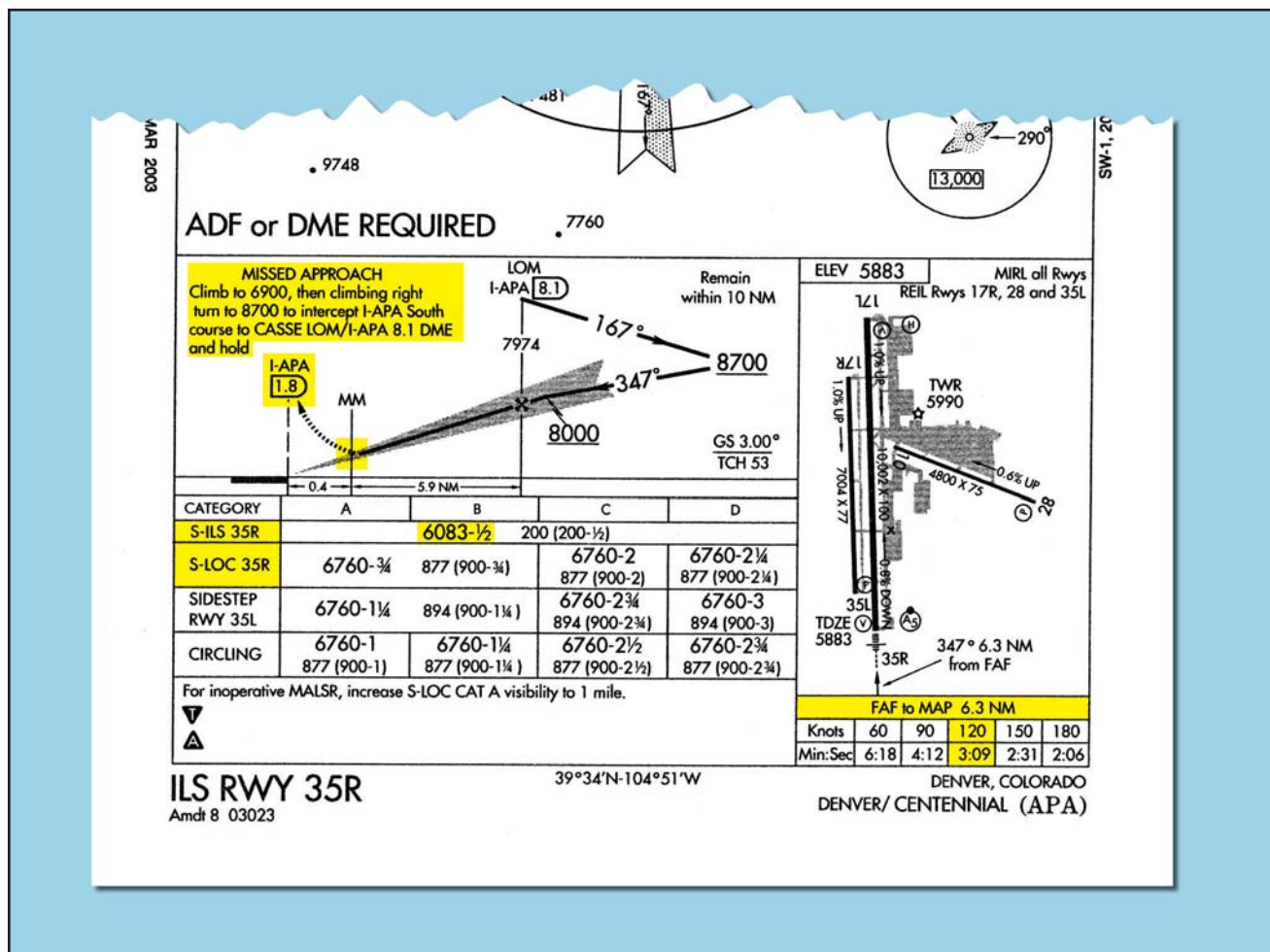

Figure 5-23. Missed Approach Point Depiction.

Instrument Approach/Operational Briefing Items

ATIS

Weather/Terrain

NOTAMS

Approaches in use

Runway conditions

Performance considerations

Feeder route/expected routing to the planned approach

Traffic

Radar/Non-radar environment

Towered/Non-towered airport

Straight-in/Circling approach

1. Airport/City name

2. Approach title

3. Page number and revision date

4. Primary/Secondary NAVAID frequencies

5. Final approach course

6. Barometric altitude at OM for crosscheck

7. Decision Altitude, Decision Height or Minimum Descent Altitude (DA, DH, or MDA)

8. Touchdown zone elevation and airport elevation

9. Missed approach procedure

10. Minimum Safe Altitude (MSA)

11. Applicable notes

12. Approach Lighting System

13. Visual glide slope indicators (VGSIs) [none in this example]

14. Required visibility (including inoperative equipment adjustments)

15. Runway length

16. Planned runway turnoff and expected taxi route

Aircraft specific items, such as autopilot, auto-brakes, auto-throttles, speed brakes, reverse thrust, etc.

Aircraft specific missed approach considerations/techniques

Additional items/duties pertaining to the situation (CAT II/III [auto-land], inoperative equipment, etc.)

Transfer of flight controls

Communications

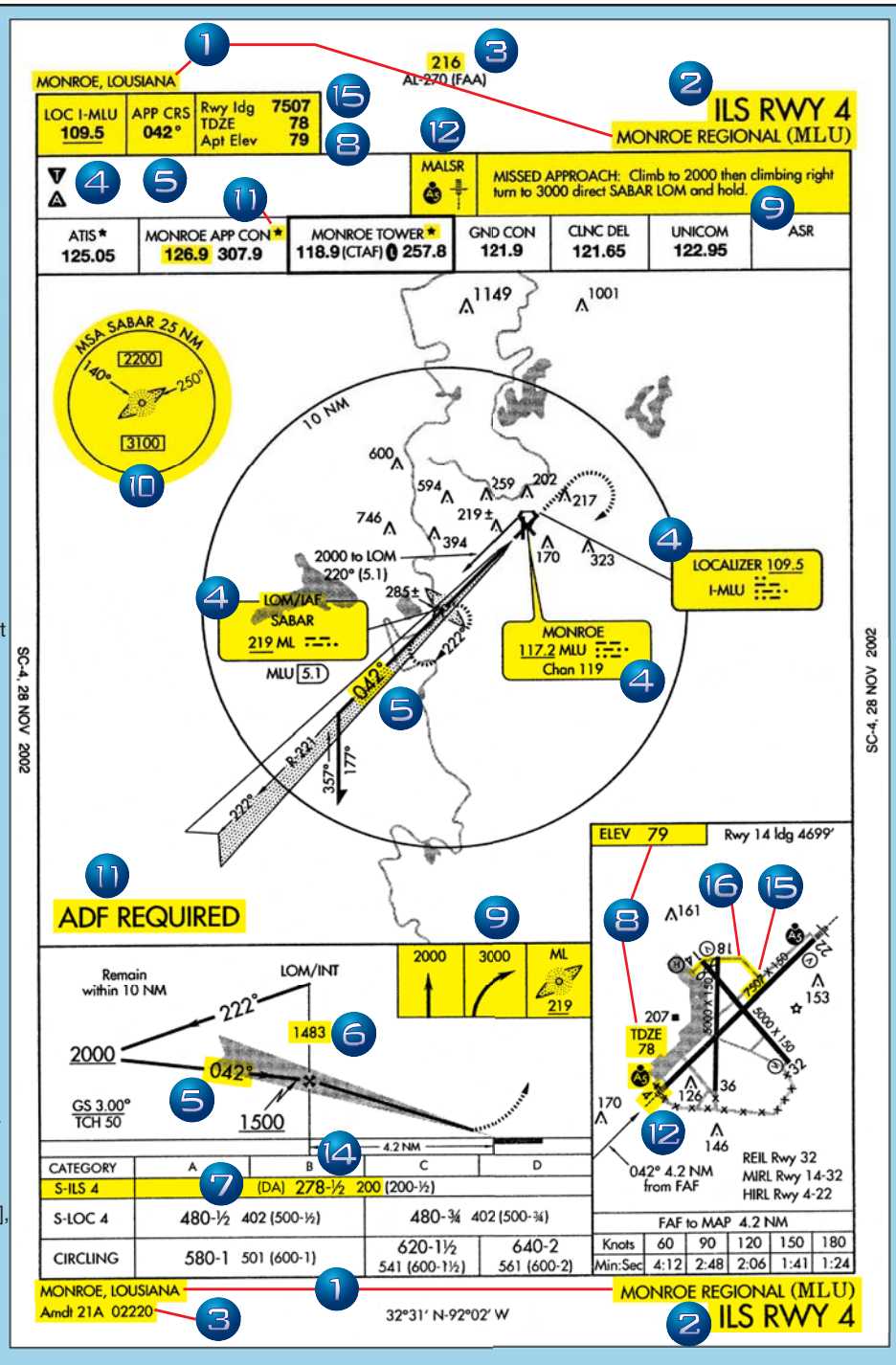

Figure 5-24. Approach Chart Briefing Sequence.

final approach course, and the traffic situation. As the discussion progresses, the items and format of the briefing become more specific. The briefing can also be used as a checklist to ensure that all items have been set up correctly. Most pilots will verbally brief the specific missed approach procedure so that it is fresh in their minds and there is no confusion as to who is doing what during a missed approach. Also, it is a very good idea to brief the published missed approach even if the tower will most likely give you alternate instructions in the

event of a missed approach. A typical approach briefing might sound like the following example for a flight inbound to the Monroe Regional Airport (KMLU):

ATIS: “Monroe Regional Airport Information Bravo, time 2253 Zulu, wind 360 at 10, visibility 1 mile, mist, ceiling 300 overcast, temperature 4, dew point 3, altimeter 29.73, ILS Runway 4 approach in use, landing and departing Runway 4, advise on initial contact that you have information Bravo.”

PF (F/O): “We’re planning an ILS approach to Runway 4 at Monroe Regional Airport, page 216, Amdt 21 Alpha. Localizer frequency is 109.5, SABAR Locator Outer Marker is 219, Monroe VOR is 117.2, final approach course is 042°, we’ll cross SABAR at 1,483 feet barometric, decision altitude is 278 feet barometric, touchdown zone elevation is 78 feet with an airport elevation of 79 feet. Missed approach procedure is climb to 2,000 feet, then climbing right turn to 3,000 feet direct SABAR locator outer marker and hold. The MSA is 2,200 feet to the north and along our missed approach course, and 3,100 feet to the south along the final approach course. ADF is required for the approach and the airport has pilot controlled lighting when the tower is closed, which does not apply to this approach. The runway has a medium intensity approach lighting system with runway alignment indicator lights and no VGSI. We need a half-mile visibility so with one mile we should be fine. Runway length is 7,507 feet. I’m planning a flaps 30 approach, autobrakes 2, left turn on Alpha or Charlie 1 then Alpha, Golf to the ramp. With a left crosswind, the runway should be slightly to the right. I’ll use the autopilot until we break out and, after landing, I’ll slow the aircraft straight ahead until you say you have control and I’ll contact ground once we are clear of the runway. In the case of a missed approach, I’ll press TOGA (Take-off/Go

Around button used on some turbojet aircraft), call ‘go-around thrust, flaps 15, positive climb, gear up, set me up,’ climb straight ahead to 2,000 feet then climbing right turn to 3,000 feet toward SABAR or we’ll follow the tower’s instructions. Any questions?”

PNF (CAP): “I’ll back up the auto-speedbrakes. Other than that, I don’t have any questions.”

INSTRUMENT APPROACH PROCEDURE SEGMENTS

An instrument approach may be divided into as many as four approach segments: initial, intermediate, final, and missed approach. Additionally, feeder routes provide a transition from the en route structure to the IAF. The U.S. Standard for Terminal Instrument Procedures (TERPS) criteria provides obstacle clearance for each segment of an approach procedure as shown in figure 5-25.

FEEDER ROUTES

By definition, a **feeder route** is a route depicted on IAP charts to designate courses for aircraft to proceed from the en route structure to the IAF. Feeder routes, also referred to as approach transitions, technically are not considered approach segments but are an integral part of many IAPs. Although an approach procedure may

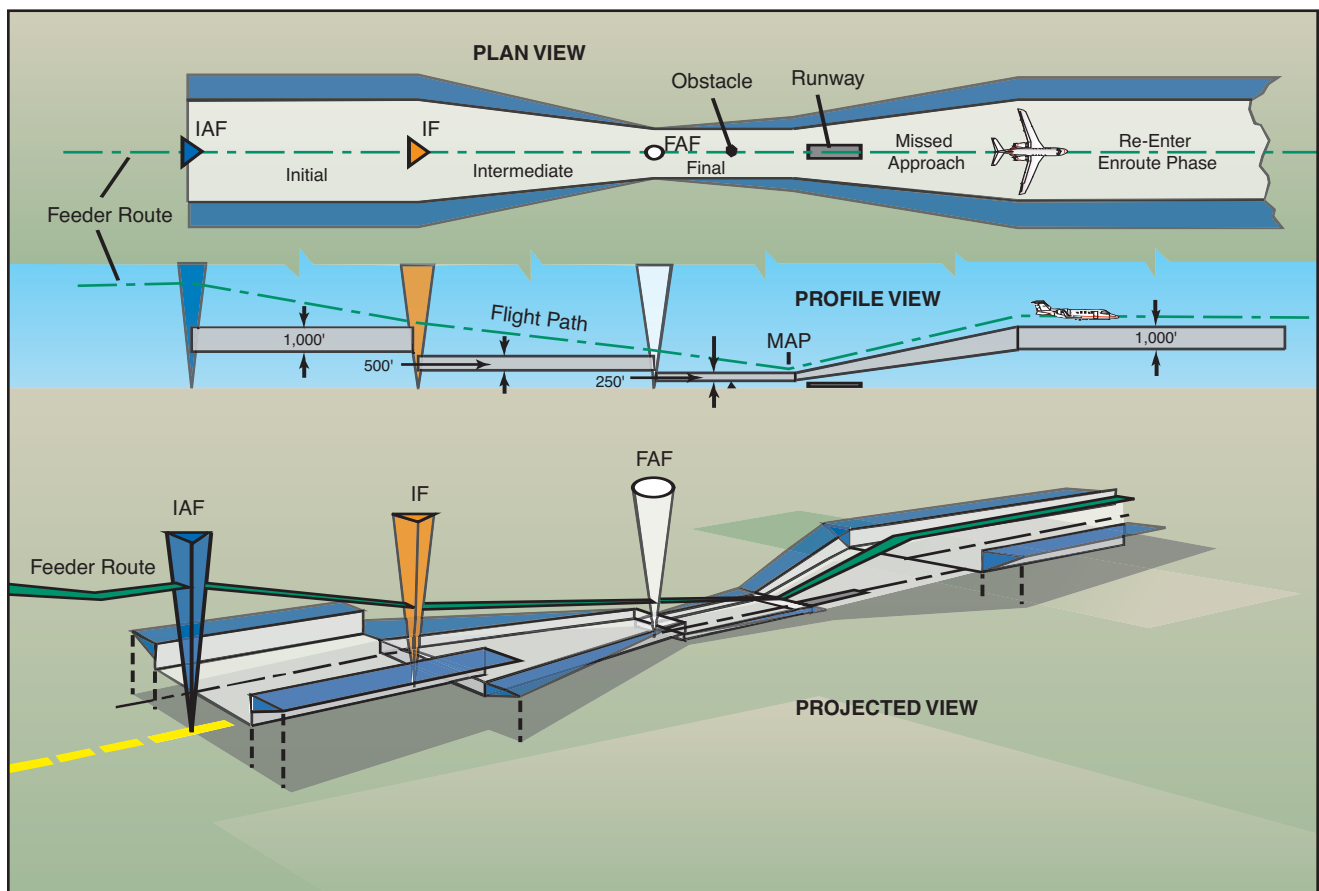

Figure 5-25. Approach Segments and Obstacle Clearance.

have several feeder routes, pilots normally choose the one closest to the en route arrival point. When the IAF is part of the en route structure, there may be no need to designate additional routes for aircraft to proceed to the IAF.

When a feeder route is designated, the chart provides the course or bearing to be flown, the distance, and the minimum altitude. En route airway obstacle clearance criteria apply to feeder routes, providing 1,000 feet of obstacle clearance (2,000 feet in mountainous areas).

TERMINAL ROUTES

In cases where the IAF is part of the en route structure and feeder routes are not required, a transition or terminal route is still needed for aircraft to proceed from the IAF to the intermediate fix (IF). These routes are initial approach segments because they begin at the IAF. Like feeder routes, they are depicted with course, minimum altitude, and distance to the IF. Essentially, these routes accomplish the same thing as feeder routes but they originate at an IAF, whereas feeder routes terminate at an IAF.

DME ARCS

DME arcs also provide transitions to the approach course, but DME arcs are actually approach segments while feeder routes, by definition, are not. When established on a DME arc, the aircraft has departed

the en route phase and has begun the approach and is maneuvering to enter an intermediate or final segment of the approach. DME arcs may also be used as an intermediate or a final segment, although they are extremely rare as final approach segments.

An arc may join a course at or before the IF. When joining a course at or before the IF, the angle of intersection of the arc and the course is designed so it does not exceed 120°. When the angle exceeds 90°, a radial that provides at least 2 NM of lead shall be identified to assist in leading the turn on to the intermediate course. DME arcs are predicated on DME collocated with a facility providing omnidirectional course information, such as a VOR. A DME arc cannot be based on an ILS or LOC DME source because omnidirectional course information is not provided.

Required obstruction clearance (ROC) along the arc depends on the approach segment. For an initial approach segment, a ROC of 1,000 feet is required in the primary area, which extends to 4 NM on either side of the arc. For an intermediate segment primary area the ROC is 500 feet. The initial and intermediate segment secondary areas extend 2 NM from the primary boundary area edge. The ROC starts at the primary area boundary edge at 500 feet and tapers to zero feet at the secondary area outer edge. [Figure 5-26]

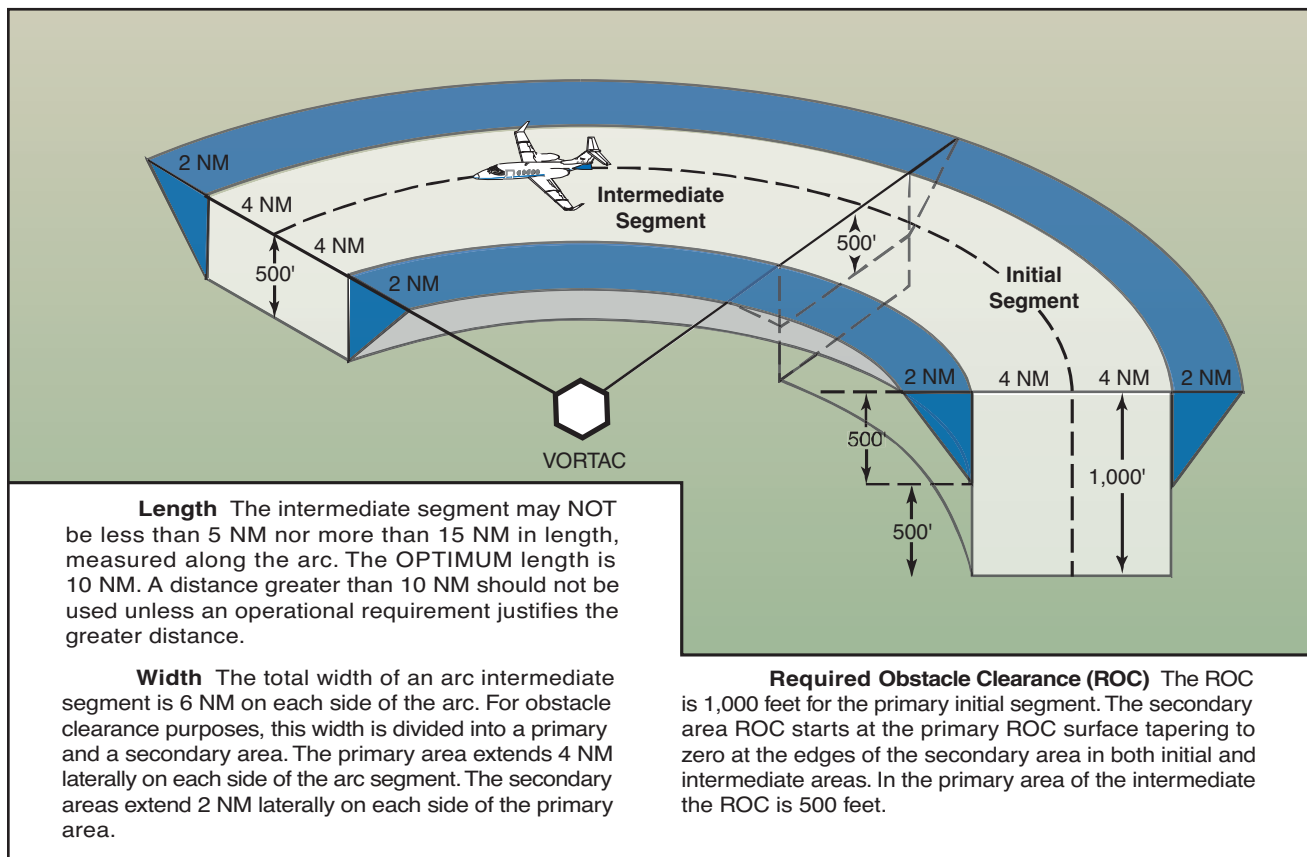

Figure 5-26. DME Arc Obstruction Clearance.

COURSE REVERSAL

Some approach procedures do not permit straight-in approaches unless pilots are being radar vectored. In these situations, pilots will be required to complete a procedure turn (PT) or other course reversal, generally within 10 NM of the PT fix, to establish the aircraft inbound on the intermediate or final approach segment.

If Category E airplanes are using the PT or there is a descent gradient problem, the PT distance available can be as much as 15 NM. During a procedure turn, a maximum speed of 200 knots indicated airspeed (KIAS) should be observed from first crossing the course reversal IAF through the procedure turn maneuver to ensure containment within the obstruction clearance area. Unless a holding pattern or teardrop procedure is published, the point where pilots begin the turn and the type and rate of turn are optional. If above the procedure turn minimum altitude, pilots may begin descent as soon as they cross the IAF outbound.

The 45° procedure turn, the racetrack pattern (holding pattern), the teardrop procedure turn, or the 80°/260° course reversal are mentioned in the AIM as acceptable variations for course reversal. When a holding pattern is published in place of a procedure turn, pilots must make the standard entry and follow the depicted pattern to establish the aircraft on the inbound course. Additional circuits in the holding pattern are not necessary or expected by ATC if pilots are cleared for the approach prior to returning to the fix. In the event additional time is needed to lose altitude or become better established on course, pilots should advise ATC and obtain approval for any additional turns. When a teardrop is depicted and a course reversal is required, pilots also must fly the procedural track as published.

Approach charts provide headings, altitudes, and distances for a course reversal. Published altitudes are “minimum” altitudes, and pilots must complete the maneuver within the distance specified on the profile view (typically within 10 NM). Pilots also are required to maneuver the aircraft on the procedure turn side of the final approach course. These requirements are necessary to stay within the protected airspace and maintain adequate obstacle clearance. [Figure 5-27]

A minimum of 1,000 feet of obstacle clearance is provided in the procedure turn primary area. [Figure 5-28 on the next page] In the secondary area, 500 feet of obstacle clearance is provided at the inner edge, tapering uniformly to zero feet at the outer edge. The primary and secondary areas determine obstacle clearance in both the entry and maneuvering zones. The use of entry and maneuvering zones provides further relief from obstacles. The entry zone is established to control

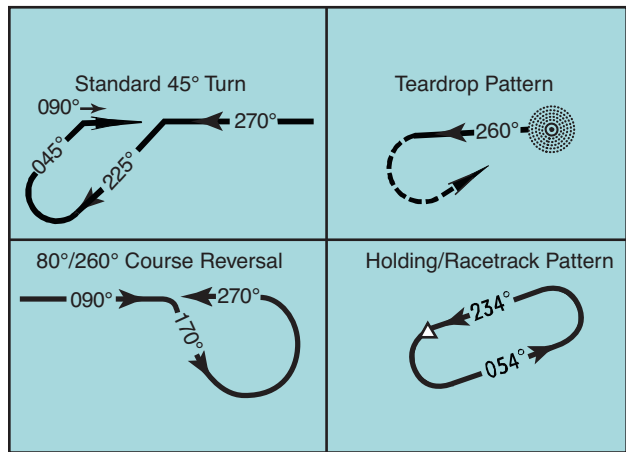

Figure 5-27. Course Reversal Methods.

the obstacle clearance prior to proceeding outbound from the procedure turn fix. The maneuvering zone is established to control obstacle clearance after proceeding outbound from the procedure turn fix.

INITIAL APPROACH SEGMENT

The purpose of the initial approach segment is to provide a method for aligning the aircraft with the intermediate or final approach segment. This is accomplished by using a DME arc, a course reversal, such as a procedure turn or holding pattern, or by following a terminal route that intersects the final approach course. The initial approach segment begins at an IAF and usually ends where it joins the intermediate approach segment or at an IF. The letters IAF on an approach chart indicate the location of an IAF and more than one may be available. Course, distance, and minimum altitudes are also provided for initial approach segments. A given procedure may have several initial approach segments. When more than one exists, each joins a common intermediate segment, although not necessarily at the same location.

Occasionally, a chart may depict an IAF, although there is no initial approach segment for the procedure. This usually occurs at a point located within the en route structure where the intermediate segment begins. In this situation, the IAF signals the beginning of the intermediate segment.

INTERMEDIATE APPROACH SEGMENT

The intermediate segment is designed primarily to position the aircraft for the final descent to the airport. Like the feeder route and initial approach segment, the chart depiction of the intermediate segment provides course, distance, and minimum altitude information.

The intermediate segment, normally aligned within 30° of the final approach course, begins at the IF, or intermediate point, and ends at the beginning of the final

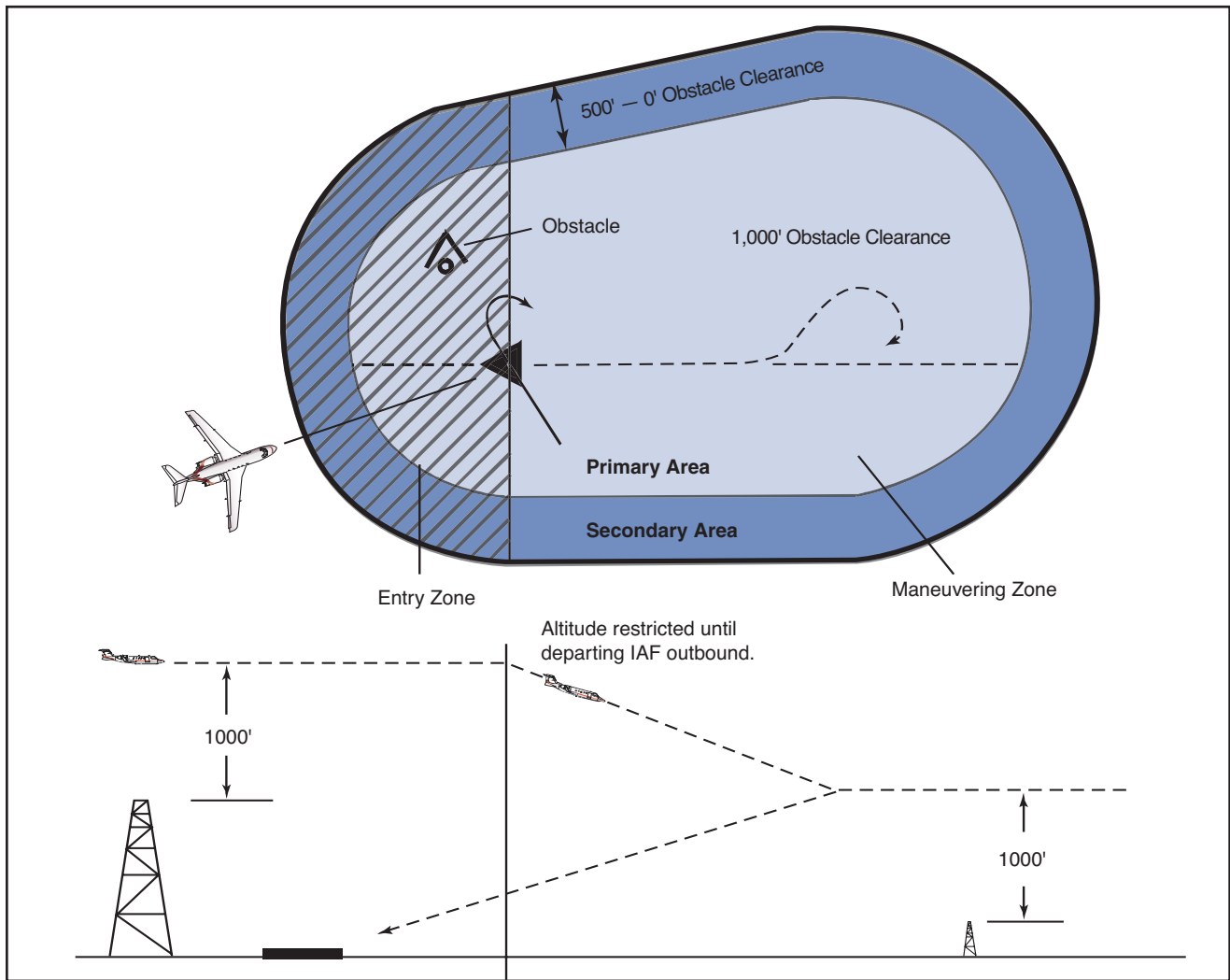

Figure 5-28. Procedure Turn Obstacle Clearance.

approach segment. In some cases, an IF is not shown on an approach chart. In this situation, the intermediate segment begins at a point where you are proceeding inbound to the FAF, are properly aligned with the final approach course, and are located within the prescribed distance prior to the FAF. An instrument approach that incorporates a procedure turn is the most common example of an approach that may not have a charted IF. The intermediate segment in this example begins when you intercept the inbound course after completing the procedure turn. [Figure 5-29]

FINAL APPROACH SEGMENT

The final approach segment for an approach with vertical guidance or a precision approach begins where the glide slope intercepts the minimum glide slope intercept altitude shown on the approach chart. If ATC authorizes a lower intercept altitude, the final approach segment begins upon glide slope interception at that altitude. For a nonprecision approach, the final approach segment begins either at a designated FAF, depicted as a cross on the profile view, or at the

point where the aircraft is established inbound on the final approach course. When a FAF is not designated, such as on an approach that incorporates an on-airport VOR or NDB, this point is typically where the procedure turn intersects the final approach course inbound. This point is referred to as the final approach point (FAP). The final approach segment ends at either the designated MAP or upon landing. There are three types of procedures based on the final approach course guidance:

- Precision Approach (PA) — an instrument approach based on a navigation system that provides course and glidepath deviation information meeting precision standards. Precision Approach Radar (PAR), ILS, and Microwave Landing System (MLS) procedures are examples of PA procedures.
- Approach with Vertical Guidance (APV) — an instrument approach based on a navigation system that is not required to meet the precision approach standards but provides course and glidepath deviation information. Baro-VNAV,

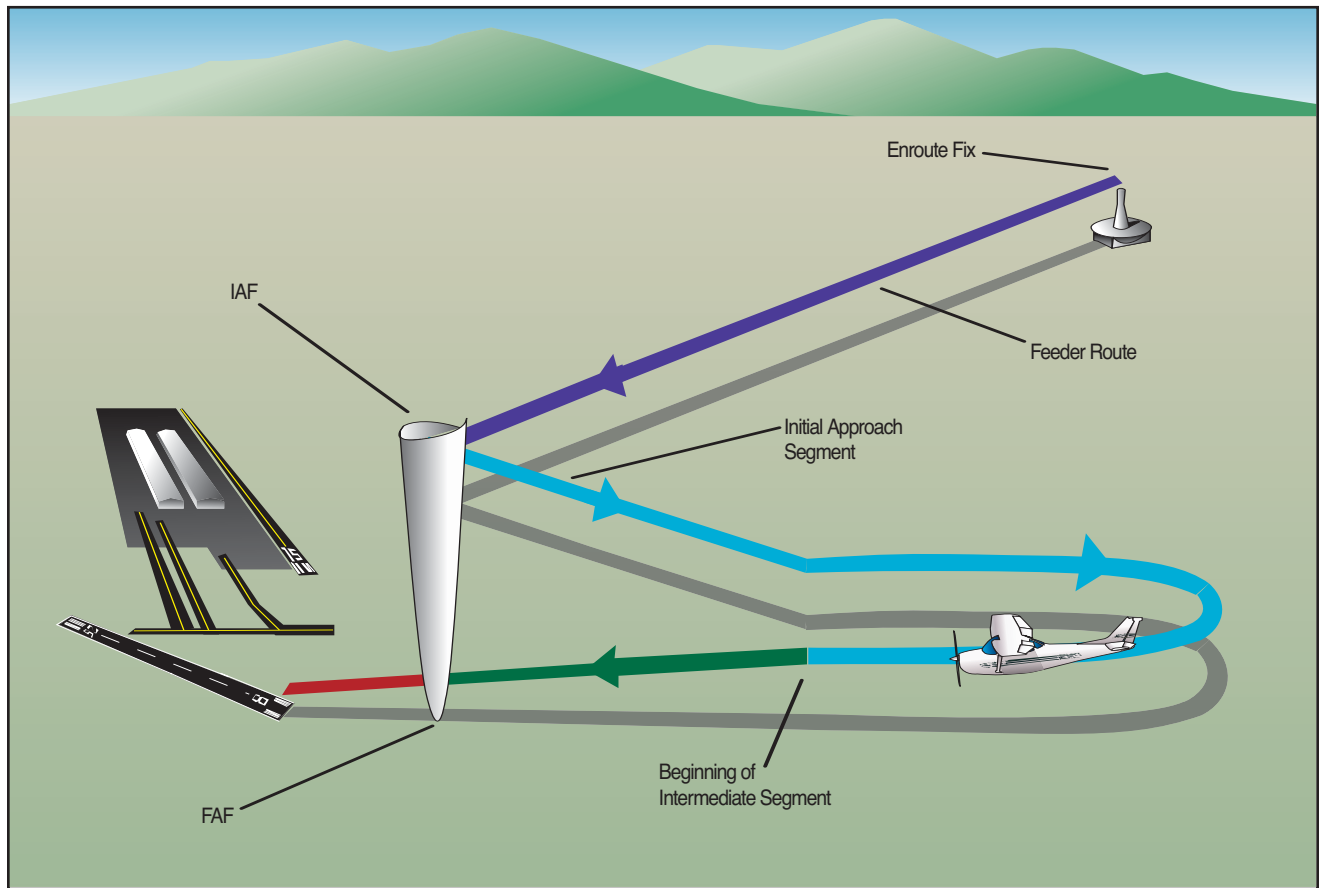

Figure 5-29. Approach without a Designated IF.

LDA with glidepath, and LPV are examples of APV approaches.

- Nonprecision Approach (NPA) — an instrument approach based on a navigation system that provides course deviation information but no glidepath deviation information is considered a NPA procedure. VOR, TACAN, LNAV, NDB, LOC and ASR approaches are examples of NPA procedures.

MISSED APPROACH SEGMENT

The missed approach segment begins at the MAP and ends at a point or fix where an initial or en route segment begins. The actual location of the MAP depends upon the type of approach you are flying. For example, during a precision or an APV approach, the MAP occurs at the DA or DH on the glide slope. For nonprecision approaches, the MAP is either a fix, NAVAID, or after a specified period of time has elapsed after crossing the FAF.

APPROACH CLEARANCE

According to *FAA Order 7110.65, Air Traffic Control*, clearances authorizing instrument approaches are issued on the basis that, if visual contact with the ground is made before the approach is completed, the

entire approach procedure will be followed unless the pilot receives approval for a contact approach, is cleared for a visual approach, or cancels the IFR flight plan.

Approach clearances are issued based on known traffic. The receipt of an approach clearance does not relieve the pilot of his/her responsibility to comply with applicable Parts of the CFRs and notations on instrument approach charts which impose on the pilot the responsibility to comply with or act on an instruction, such as “procedure not authorized at night.” The name of the approach, as published, is used to identify the approach. Approach name items within parentheses are not included in approach clearance phraseology.

VECTORS TO FINAL APPROACH COURSE

The approach gate is an imaginary point used within ATC as a basis for vectoring aircraft to the final approach course. The gate will be established along the final approach course one mile from the FAF on the side away from the airport and will be no closer than 5 NM from the landing threshold. Controllers are also required to ensure the assigned altitude conforms to the following:

- For a precision approach, at an altitude not above the glide slope/glidepath or below the minimum glide slope intercept altitude specified on the approach procedure chart.
- For a nonprecision approach, at an altitude which will allow descent in accordance with the published procedure.

Further, controllers must assign headings that will permit final approach course interception without exceeding the following:

Distance from Interception Point to Approach Gate	Maximum Interception Angle
<ul style="list-style-type: none"> • Less than 2 NM or with triple simultaneous ILS/MLS approaches in use. 	20°
<ul style="list-style-type: none"> • 2 NM or more 	30° (45° for helicopters)

A typical vector to the final approach course and associated approach clearance is as follows:

“...four miles from LIMA, turn right heading three four zero, maintain two thousand until established on the localizer, cleared ILS runway three six approach.”

Other clearance formats may be used to fit individual circumstances but the controller should always assign an altitude to maintain until the aircraft is established on a segment of a published route or IAP. The altitude assigned must guarantee IFR obstruction clearance from the point at which the approach clearance is issued until the aircraft is established on a published route. Part 91.175 (j) prohibits a pilot from making a procedure turn when vectored to a FAF or course, when conducting a timed approach, or when the procedure specifies “NO PT.”

When vectoring aircraft to the final approach course, controllers are required to ensure the intercept is at least 2 NM outside the approach gate. Exceptions include the following situations:

- When the reported ceiling is at least 500 feet above the MVA/MIA and the visibility is at least 3 SM (may be a pilot report [PIREP] if no weather is reported for the airport), aircraft may be vectored to intercept the final approach course closer than 2 NM outside the approach gate but no closer than the approach gate.

If specifically requested by the pilot, aircraft may be vectored to intercept the final approach course inside the approach gate but no closer than the FAF.

RNAV equipped aircraft shall be vectored to the IF to allow the onboard avionics to stabilize on the inbound course.

NONRADAR ENVIRONMENT

In the absence of radar vectors, an instrument approach begins at an IAF. An aircraft that has been cleared to a holding fix that, prior to reaching that fix, is issued a clearance for an approach, but not issued a revised routing, such as, “*proceed direct to...*” is expected to proceed via the last assigned route, a feeder route if one is published on the approach chart, and then to commence the approach as published. If, by following the route of flight to the holding fix, the aircraft would overfly an IAF or the fix associated with the beginning of a feeder route to be used, the aircraft is expected to commence the approach using the published feeder route to the IAF or from the IAF as appropriate. The aircraft would not be expected to overfly and return to the IAF or feeder route.

For aircraft operating on unpublished routes, an altitude is assigned to maintain until the aircraft is established on a segment of a published route or IAP. (Example: “*maintain 2,000 until established on the final approach course outbound, cleared VOR/DME runway 12.*”) The International Civil Aviation Organization (ICAO) definition of established on course requires the aircraft to be within half scale deflection for the ILS and VOR, or within $\pm 5^\circ$ of the required bearing for the NDB. Generally, the controller assigns an altitude compatible with glide slope intercept prior to being cleared for the approach.

TYPES OF APPROACHES

In the NAS, there are approximately 1,033 VOR stations, 1,200 NDB stations, and 1,370 ILS installations, including 25 LOC-Type Directional Aids (LDAs), 23 Simplified Directional Facilities (SDFs), and 242 LOC only facilities. As time progresses, it is the intent of the FAA to reduce navigational dependence on VOR, NDB, and other ground-based NAVAIDs and, instead, to increase the use of satellite-based navigation.

To expedite the use of RNAV procedures for all instrument pilots, the FAA has begun an aggressive schedule to develop RNAV procedures. During 2002, the number of RNAV/GPS approaches published in the NAS exceeded 3,300, with additional procedures published every revision cycle. While it had originally been the plan of the FAA to begin decommissioning VORs, NDBs, and other ground-based NAVAIDs, the overall strategy has been changed to incorporate a majority dependence on augmented satellite navigation while maintaining a satisfactory backup system. This backup system will include retaining all CAT II and III ILS facilities and close to one-half of the existing VOR network.

Each approach is provided obstacle clearance based on the Order 8260.3 TERPS design criteria as appropriate for the surrounding terrain, obstacles, and NAVAID availability. Final approach obstacle clearance is different for every type of approach but is guaranteed from the start of the final approach segment to the runway (not below the MDA for nonprecision approaches) or MAP, whichever occurs last within the final approach area. Both pilots and ATC assume obstacle clearance responsibility, but it is dependent upon the pilot to maintain an appropriate flight path within the boundaries of the final approach area.

There are numerous types of instrument approaches available for use in the NAS including RNAV (GPS), ILS, MLS, LOC, VOR, NDB, SDF, and radar approaches. Each approach has separate and individual design criteria, equipment requirements, and system capabilities.

VISUAL AND CONTACT APPROACHES

To expedite traffic, ATC may clear pilots for a **visual approach** in lieu of the published approach procedure if flight conditions permit. Requesting a **contact approach** may be advantageous since it requires less time than the published IAP and provides separation from IFR and special visual flight rules (SVFR) traffic. A contact or visual approach may be used in lieu of conducting a SIAP, and both allow the flight to continue as an IFR flight to landing while increasing the efficiency of the arrival.

VISUAL APPROACHES

When it is operationally beneficial, ATC may authorize pilots to conduct a visual approach to the airport in lieu of the published IAP. A pilot or the controller can initiate a visual approach. Before issuing a visual approach clearance, the controller must verify that pilots have the airport, or a preceding aircraft that they are to follow, in sight. In the event pilots have the airport in sight but do not see the aircraft they are to follow, ATC may issue the visual approach clearance but will maintain responsibility for aircraft and wake turbulence separation. Once pilots report the aircraft in sight, they assume the responsibilities for their own separation and wake turbulence avoidance.

A visual approach is an ATC authorization for an aircraft on an IFR flight plan to proceed visually to the airport of intended landing; it is not an IAP. Also, there is no missed approach segment. An aircraft unable to complete a visual approach shall be handled as any other go-around and appropriate separation must be provided. A vector for a visual approach may be initiated by ATC if the reported ceiling at the airport of intended landing is at least

500 feet above the MVA/MIA and the visibility is 3 SM or greater. At airports without weather reporting service there must be reasonable assurance (e.g. area weather reports, PIREPs, etc.) that descent and approach to the airport can be made visually, and the pilot must be informed that weather information is not available.

The visual approach clearance is issued to expedite the flow of traffic to an airport. It is authorized when the ceiling is reported or expected to be at least 1,000 feet AGL and the visibility is at least 3 SM. Pilots must remain clear of the clouds at all times while conducting a visual approach. At an airport with a control tower, pilots may be cleared to fly a visual approach to one runway while others are conducting VFR or IFR approaches to another parallel, intersecting, or converging runway. Also, when radar service is provided, it is automatically terminated when the controller advises pilots to change to the tower or advisory frequency.

CONTACT APPROACHES

If conditions permit, pilots can request a contact approach, which is then authorized by the controller. A contact approach cannot be initiated by ATC. This procedure may be used instead of the published procedure to expedite arrival, as long as the airport has a SIAP or **special instrument approach procedure** (special IAPs are approved by the FAA for individual operators, but are not published in Part 97 for public use), the reported ground visibility is at least 1 SM, and pilots are able to remain clear of clouds with at least one statute mile flight visibility throughout the approach. Some advantages of a contact approach are that it usually requires less time than the published instrument procedure, it allows pilots to retain the IFR clearance, and provides separation from IFR and SVFR traffic. On the other hand, obstruction clearances and VFR traffic avoidance becomes the pilot's responsibility. Unless otherwise restricted, the pilot may find it necessary to descend, climb, or fly a circuitous route to the airport to maintain cloud clearance or terrain/obstruction clearance.

The main differences between a visual approach and a contact approach are: a pilot must request a contact approach, while a visual approach may be assigned by ATC or requested by the pilot; and, a contact approach may be approved with 1 mile visibility if the flight can remain clear of clouds, while a visual approach requires the pilot to have the airport in sight, or a preceding aircraft to be followed, and the ceiling must be at least 1,000 feet AGL with at least 3 SM visibility.

CHARTED VISUAL FLIGHT PROCEDURES

A **charted visual flight procedure (CVFP)** may be established at some airports with control towers for environmental or noise considerations, as well as when

necessary for the safety and efficiency of air traffic operations. Designed primarily for turbojet aircraft, CVFPs depict prominent landmarks, courses, and recommended altitudes to specific runways. When pilots are flying the Roaring Fork Visual RWY 15 shown in figure 5-30, mountains, rivers, and towns provide guidance to Aspen, Colorado's Sardy Field instead of VORs, NDBs, and DME fixes.

Pilots must have a charted visual landmark or a preceding aircraft in sight, and weather must be at or above the published minimums before ATC will issue a CVFP clearance. ATC will clear pilots for a CVFP if the reported ceiling at the airport of intended landing is at least 500 feet above the MVA/MIA, and the visibility is 3 SM or more, unless higher minimums are published for the particular CVFP. When accepting a clearance to

follow a preceding aircraft, pilots are responsible for maintaining a safe approach interval and wake turbulence separation. Pilots must advise ATC if unable at any point to continue a charted visual approach or if the pilot loses sight of the preceding aircraft.

RNAV APPROACHES

Because of the complications with database coding, naming conventions were changed in January 2001 to accommodate all approaches using RNAV equipment into one classification — RNAV. This classification includes both ground-based and satellite dependent systems. Eventually all approaches that use some type of RNAV will reflect RNAV in the approach title. This changeover is being made to reflect two shifts in instrument approach technology. The first shift is the use of the RNP concept outlined in Chapter 2 —

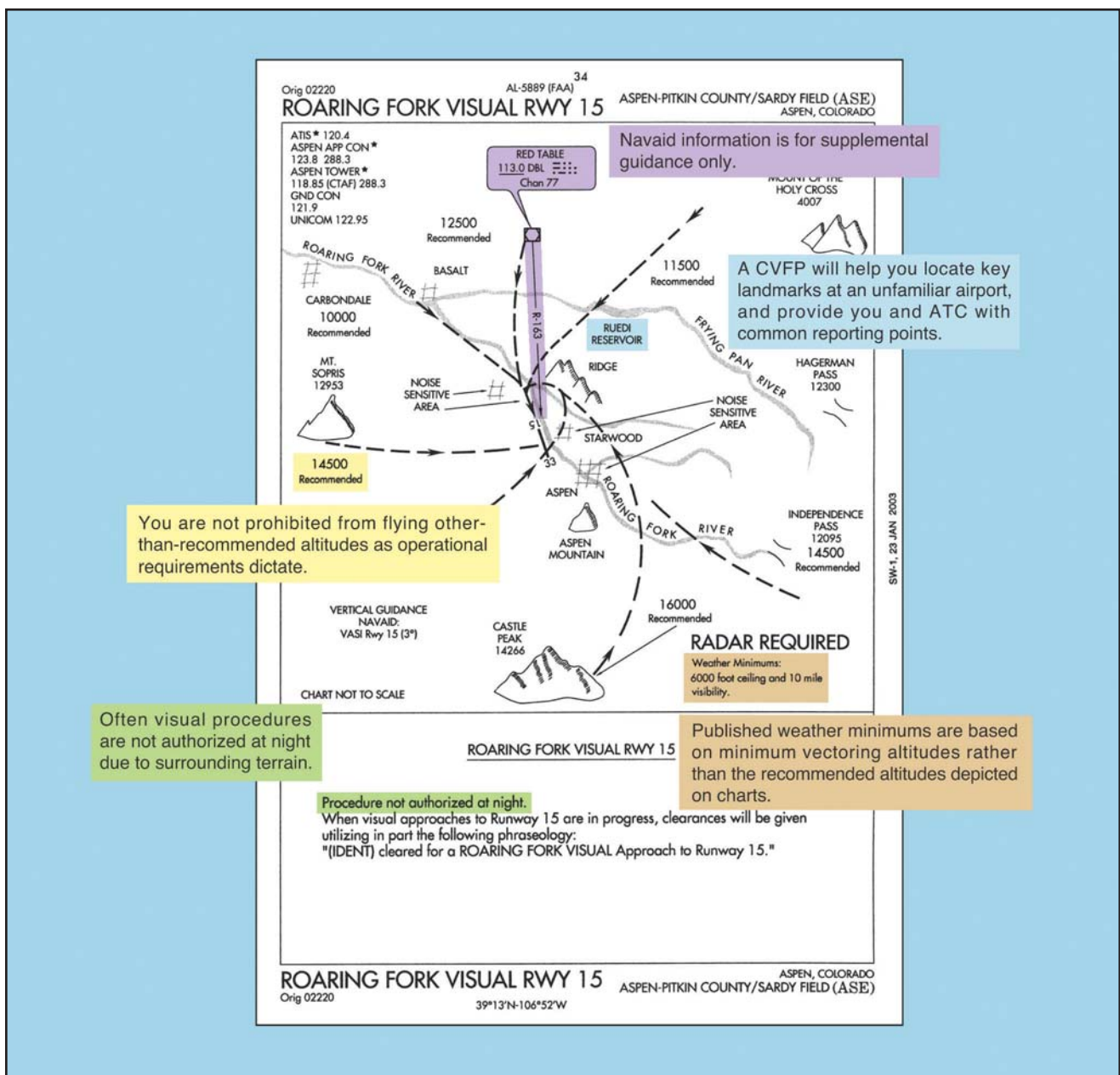

Figure 5-30. Charted Visual Flight Procedures.

Departure Procedures, in which a single performance standard concept is being implemented for approach procedure design. Through the use of RNP, the underlying system of navigation will not be required, provided the aircraft can maintain the appropriate RNP standard. The second shift is that advanced avionics systems such as FMSs, used by most airlines, needed a new navigation standard by which RNAV could be fully integrated into the instrument approach system. An FMS uses multi-sensor navigation inputs to produce a composite position. Essentially, the FMS navigation function automatically blends or selects position sensors to compute aircraft position. Instrument approach charts and RNAV databases needed to change to reflect these issues. A complete discussion of airborne navigation databases is included in Appendix A — Airborne Navigation Databases.

Due to the multi-faceted nature of RNAV, new approach criteria have been developed to accommodate the design of RNAV instrument approaches. This includes criteria for TAAs, RNAV basic approach cri-

teria, and specific final approach criteria for different types of RNAV approaches.

TERMINAL ARRIVAL AREAS

TAAs are the method by which aircraft are transitioned from the RNAV en route structure to the terminal area with minimal ATC interaction. Terminal arrival areas are depicted in the planview of the approach chart, and each waypoint associated with them is also provided with a unique five character, pronounceable name. The TAA consists of a designated volume of airspace designed to allow aircraft to enter a protected area, offering guaranteed obstacle clearance where the initial approach course is intercepted based on the location of the aircraft relative to the airport. Where possible, TAAs are developed as a basic “T” shape that is divided into three separate arrival areas around the head of the “T”: left base, right base, and straight-in. Typically, the TAA offers an IAF at each of these three arrival areas that are 3-6 NM from an IF, which often doubles as the IAF for straight-in approaches, a FAF located approximately 5 NM from the runway threshold, and a MAP. [Figure 5-31]

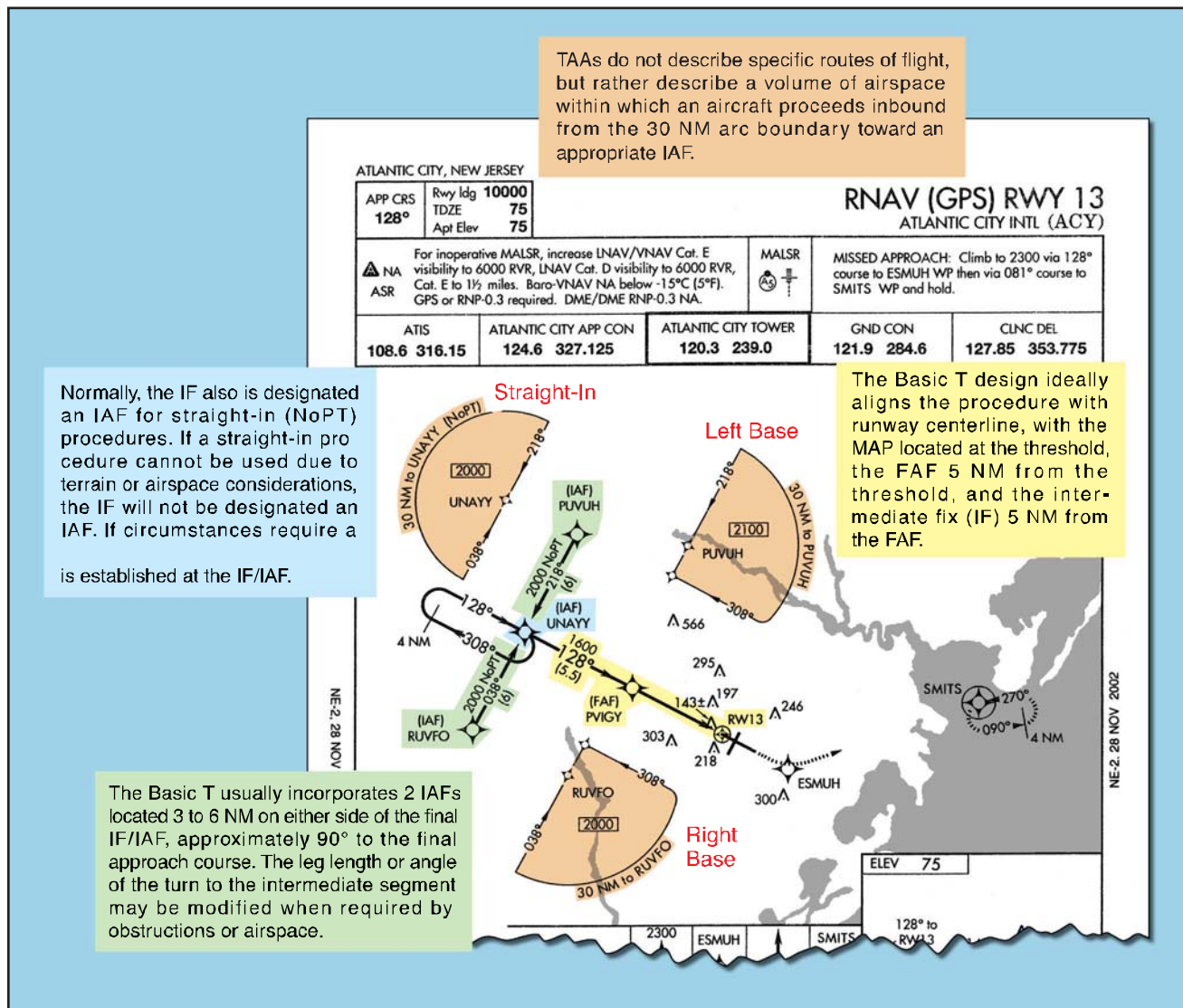

Figure 5-31. Terminal Arrival Area Design (Basic “T”).

Procedurally, pilots may be cleared to an IAF associated with the TAA. ATC expects the flight to proceed to the IAF and maintain the altitude depicted for that area of the TAA, unless cleared otherwise. An obstacle clearance of at least 1,000 feet is guaranteed within the boundaries of the TAA.

TAAAs are modified or even eliminated if necessary to meet the requirements of a specific airport and surrounding terrain, or airspace considerations negating the use of the “T” approach design concept. Alternative designs are addressed in *FAA Order 8260.45A, Terminal Arrival Area (TAA) Design Criteria*. Variations may eliminate one or both base areas, and/or limit or modify the angular size of the straight-in area. When both base areas are eliminated, TAAAs are not depicted in the planview. Normally, a portion of the TAA underlies an airway. If this is not the case, at least one feeder route is provided from an airway fix or NAVAID to the TAA boundary. The feeder route provides a direct course from the en route fix/NAVAID to the appropriate IF/IAF. Multiple feeder routes may also be established. In some cases, TAAAs may not be depicted because of airspace congestion or other operational requirements. [Figure 5-32]

RNAV FINAL APPROACH DESIGN CRITERIA

RNAV encompasses a variety of underlying navigation systems and, therefore, approach criteria. This results in different sets of criteria for the final approach segment of various RNAV approaches. RNAV instrument approach criteria address the following procedures:

- GPS overlay of pre-existing nonprecision approaches.
- VOR/DME based RNAV approaches.
- Stand-alone RNAV (GPS) approaches.
- RNAV (GPS) approaches with vertical guidance (APV).
- RNAV (GPS) precision approaches (WAAS and LAAS).

GPS OVERLAY OF NONPRECISION APPROACH

The original GPS approach procedures provided authorization to fly nonprecision approaches based on conventional, ground-based NAVAIDs. Many of these approaches have been converted to stand-alone approaches, and the few that remain are identified by the name of the procedure and “or GPS.” These GPS nonprecision approaches are predicated upon the design criteria of the ground-based NAVAID used as the basis of the approach. As such, they do not adhere to the RNAV design criteria for stand-alone GPS approaches, and are not considered part of the RNAV (GPS) approach classification for determining design criteria. [Figure 5-33 on page 5-46]

GPS STAND-ALONE/RNAV (GPS) APPROACH

RNAV (GPS) approaches are named so that airborne navigation databases can use either GPS or RNAV as the title of the approach. This is required for non-GPS approach systems such as VOR/DME based RNAV systems. In the past, these approaches were often referred to as stand-alone GPSs. They are considered nonprecision approaches, offering only LNAV and circling minimums. Precision minimums are not authorized, although LNAV/VNAV minimums may be published and used as long as the on-board system is capable of providing approach approved VNAV. The RNAV (GPS) Runway 18 approach for Alexandria, Louisiana incorporates only LNAV and circling minimums. [Figure 5-34 on page 5-47]

For a straight-in RNAV (GPS) approach, the final approach course must be aligned within 15° of the extended runway centerline. The final approach segment should not exceed 10 NM, and when it exceeds 6 NM, a stepdown fix is typically incorporated. A minimum of 250 feet obstacle clearance is also incorporated into the final approach segment for straight-in approaches, and a maximum 400-foot per NM descent gradient is permitted.

The approach design criteria are different for approaches that use vertical guidance provided by a Baro-VNAV system. Baro-VNAV approaches are not authorized in areas of hazardous terrain, nor are they authorized when a remote altimeter setting is required. Due to the inherent problems associated with barometric readings and cold temperatures, these procedures are also temperature limited. Additional approach design criteria for Baro-VNAV approaches are contained in TERPS and *FAA Order 8260.48 – RNAV Approach Construction Criteria*. Instrument Procedure with Vertical Guidance (IPV), as defined in *Order 8260.48*, has been renamed APV.

RNAV (GPS) APPROACH USING WAAS

WAAS was commissioned in July, 2003, with initial operational capability (IOC). Although precision approach capability is still in the future, initial WAAS currently provides a new type of approach with vertical guidance (APV) known as LPV. Approach minimums as low as 250 feet HAT and 1/2 SM visibility will be possible, even though LPV is not considered a precision approach. WAAS covers 95 percent of the country 95 percent of the time.

NOTE: WAAS avionics must be certified in accordance with Technical Standard Order (TSO) C-145A, *Airborne Navigation Sensors Using the (GPS) Augmented by the Wide Area Augmentation System (WAAS)*, or TSO-146A, *Stand-Alone Airborne Navigation Equipment Using the Global Positioning System (GPS) Augmented by the Wide Area*

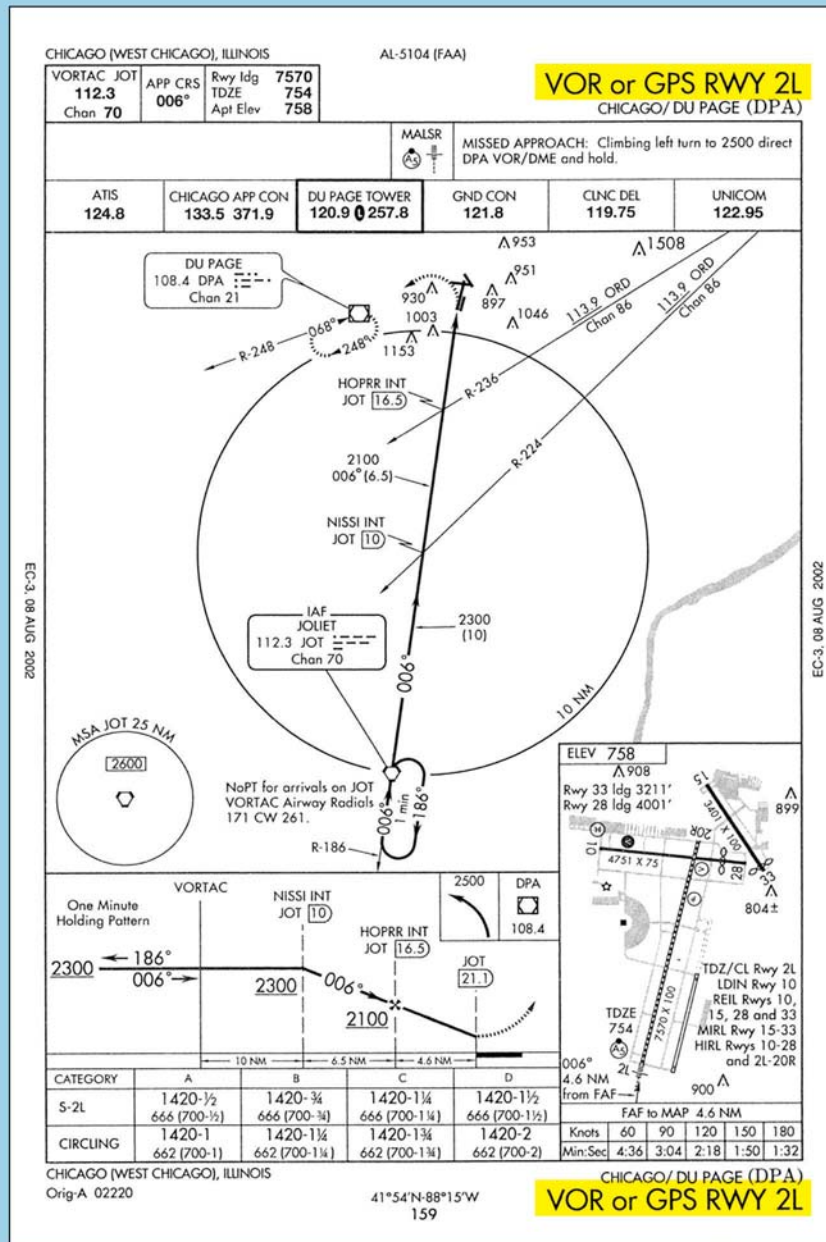

Figure 5-33. Traditional GPS Overlay Approach.

Augmentation System (WAAS), and installed in accordance with AC 20-130A, *Airworthiness Approval of Navigation or Flight Management Systems Integrating Multiple Navigation Sensors*, or AC 20-138A, *Airworthiness Approval of Global Positioning System (GPS) Navigation Equipment for Use as a VFR and IFR Navigation System*.

Precision approach capability will be available in the future when WAAS reaches full operational capability (FOC), and when the local area augmentation system (LAAS) becomes operational. LAAS further increases the accuracy of GPS and improves signal integrity warnings. Precision approach capability requires obstruction planes and approach lighting systems to

meet Part 77 standards for ILS approaches. This will delay the implementation of RNAV (GPS) precision approach capability due to the cost of certifying each runway.

ILS APPROACHES

Notwithstanding emerging RNAV technology, the ILS is the most precise and accurate approach NAVAID currently in use throughout the NAS. An ILS CAT I precision approach allows approaches to be made to 200 feet above the TDZE and with visibilities as low as 1,800 RVR; with CAT II and CAT III approaches allowing descents and visibility minimums that are even lower. Nonprecision approach alternatives cannot begin to offer the precision or flexibility offered by an

to execute a simultaneous approach. Pilots must comply with all ATC requests in a timely manner, and maintain strict radio discipline, including using complete aircraft call signs. It is also incumbent upon the flight crew to notify ATC immediately of any problems relating to aircraft communications or navigation systems. At the very least, the approach procedure briefing should cover the entire approach procedure including the approach name, runway number, frequencies, final approach course, glide slope intercept altitude, DA or DH, and the missed approach instructions. The review of autopilot procedures is also appropriate when making coupled ILS or MLS approaches.

As with all approaches, the primary navigation responsibility falls upon the pilot in command. ATC instructions will be limited to ensuring aircraft separation. Additionally, missed approach procedures are normally designed to diverge in order to protect all involved aircraft. ILS approaches of all types are afforded the same obstacle clearance protection and design criteria, no matter how capacity is affected by multiple ILS approaches. [Figure 5-35]

ILS APPROACH CATEGORIES

There are three general classifications of ILS approaches — CAT I, CAT II, and CAT III (autoland). The basic ILS approach is a CAT I approach and requires only that pilots be instrument rated and current, and that the aircraft be equipped appropriately. CAT II and CAT III ILS approaches typically have lower minimums and require special certification for operators, pilots, aircraft, and airborne/ground

equipment. Because of the complexity and high cost of the equipment, CAT III ILS approaches are used primarily in air carrier and military operations. [Figure 5-36]

CAT II AND III APPROACHES

The primary authorization and minimum RVRs allowed for an air carrier to conduct CAT II and III approaches can be found in OpsSpecs – Part C. CAT II and III operations allow authorized pilots to make instrument approaches in weather that would otherwise be prohibitive.

While CAT I ILS operations permit substitution of mid-field RVR for TDZ RVR (when TDZ RVR is not available), CAT II ILS operations do not permit any substitutions for TDZ RVR. The touchdown zone RVR system is required and must be used. Touchdown zone RVR is controlling for all CAT II ILS operations.

The weather conditions encountered in CAT III operations range from an area where visual references are adequate for manual rollout in CAT IIIa, to an area where visual references are inadequate even for taxi operations in CAT IIIc. To date, no U.S. operator has received approval for CAT IIIc in OpsSpecs. Depending on the auto-flight systems, some airplanes require a DH to ensure that the airplane is going to land in the touchdown zone and some require an Alert Height as a final crosscheck of the performance of the auto-flight systems. These heights are based on radio altitude (RA) and can be found in the specific aircraft's AFM. [Figure 5-37]

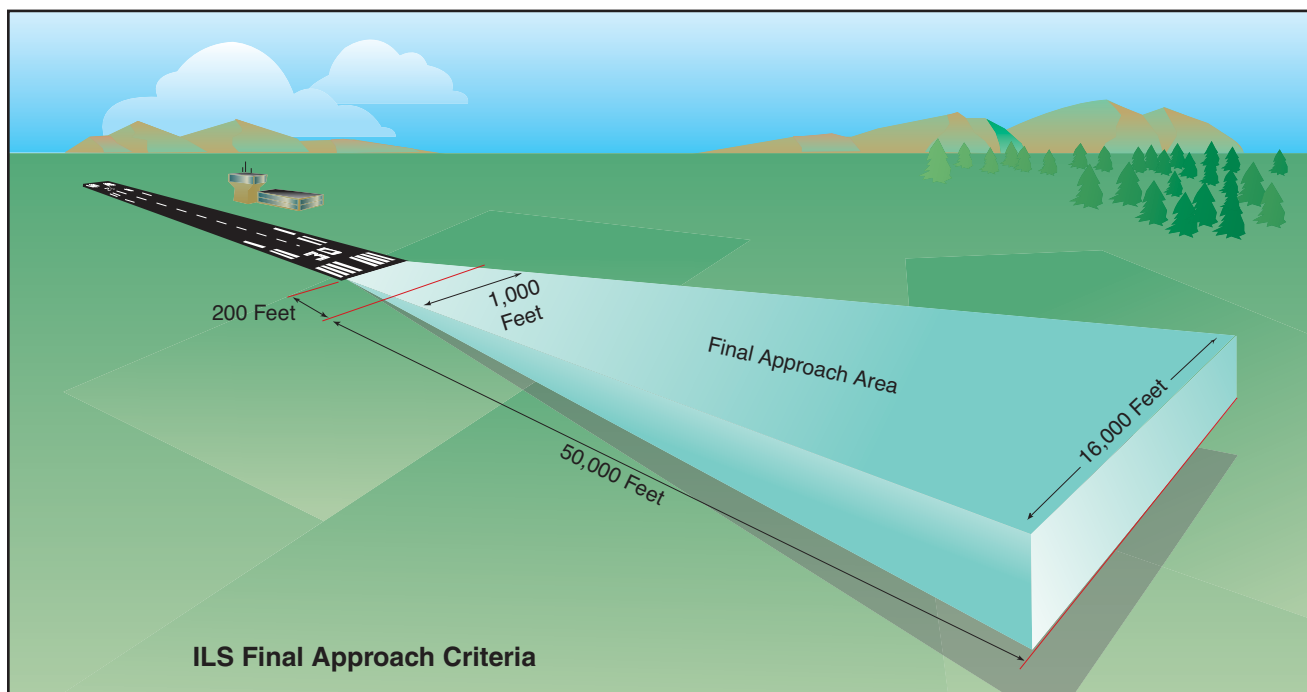

Figure 5-35. ILS Final Approach Segment Design Criteria.

- The lowest authorized ILS minimums, with all required ground and airborne systems components operative, are
- Category I — Decision Height (DH) 200 feet and Runway Visual Range (RVR) 2,400 feet (with touchdown zone and centerline lighting, RVR 1800 feet),
 - Category II — DH 100 feet and RVR 1,200 feet,
 - Category IIIa — No DH or DH below 100 feet and RVR not less than 700 feet,
 - Category IIIb — No DH or DH below 50 feet and RVR less than 700 feet but not less than 150 feet, and
 - Category IIIc — No DH and no RVR limitation.

NOTE: Special authorization and equipment are required for Category II and III.

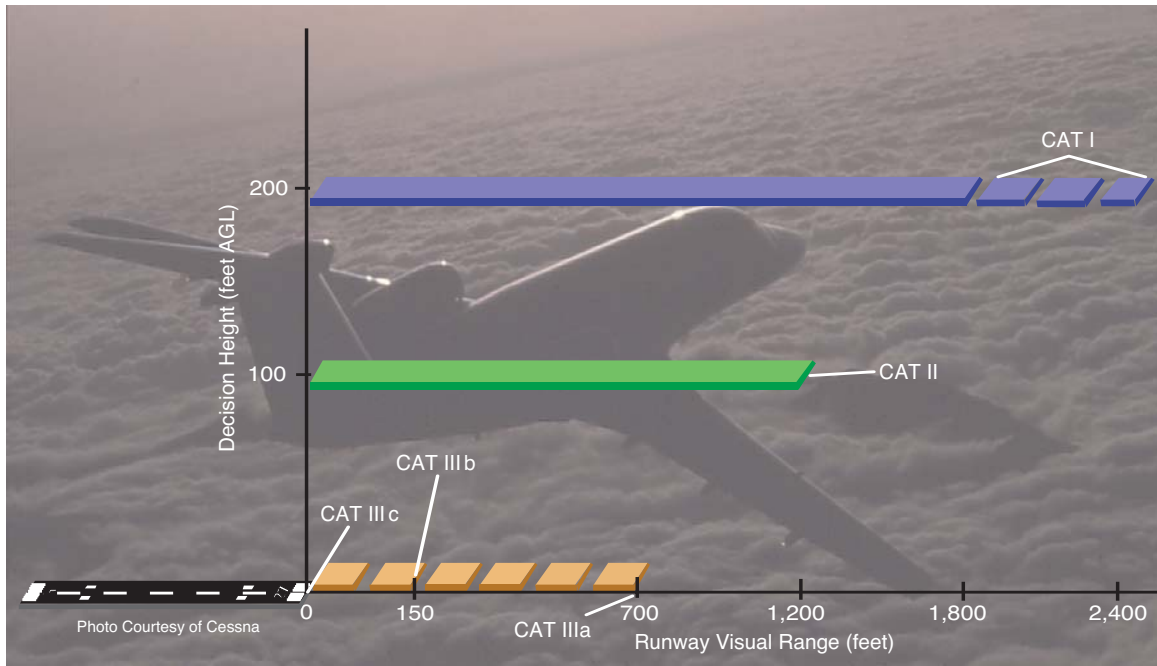

Figure 5-36. ILS Approach Categories.

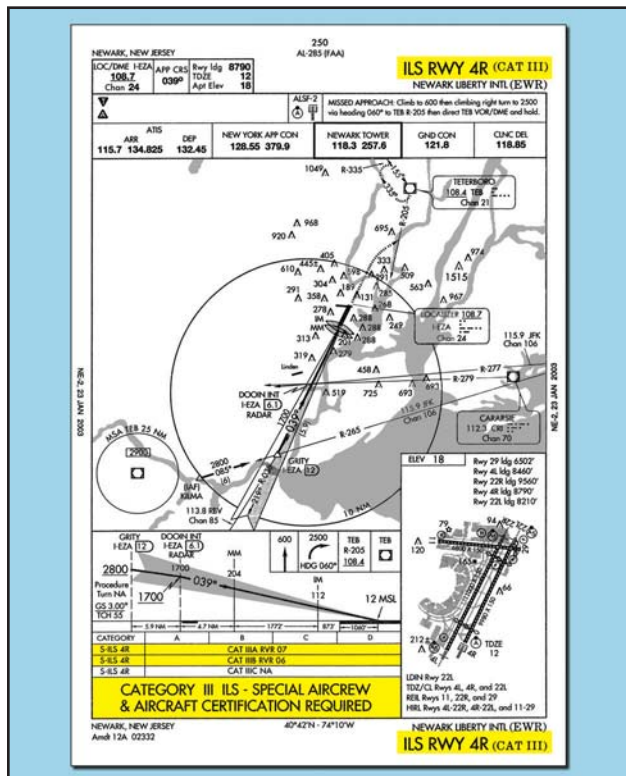

Figure 5-37. Category III Approach Procedure.

Both CAT II and III approaches require special ground and airborne equipment to be installed and operational, as well as special aircrew training and authorization. The OpsSpecs of individual air carriers detail the requirements of these types of approaches as well as their performance criteria. Lists of locations where each operator is approved to conduct CAT II and III approaches can also be found in the OpsSpecs.

ILS APPROACHES TO PARALLEL RUNWAYS

Airports that have two or three parallel runways may be authorized to use parallel approaches to maximize the capacity of the airport. There are three classifications of parallel ILS approaches, depending on the runway centerline separation and ATC procedures.

PARALLEL

Parallel (dependent) ILS approaches are allowed at airports with parallel runways that have centerlines separated by at least 2,500 feet. Aircraft are allowed to fly ILS approaches to parallel runways; however, the aircraft must be staggered by a minimum of 1½ NM diagonally. Aircraft are staggered by 2 NM diagonally for runway centerlines that are separated by more than 4,300 feet and up to but not including 9,000 feet, and that do not have final monitor air

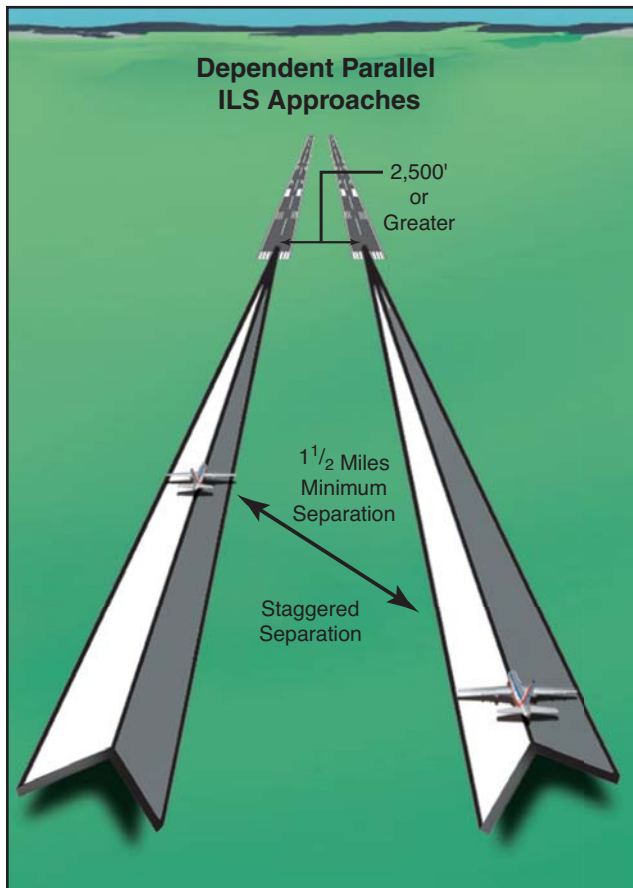

Figure 5-38. Parallel (Dependent) ILS Approach Separation Criteria.

traffic controllers. Separation for this type of approach is provided by radar. [Figure 5-38]

Though this type of approach procedure is approved for several airports, it is not required that the approach chart contain information notifying flight crews of the use of parallel approaches. Therefore, a pilot may not know that parallel approaches are approved or used at a specific airport based on the information contained on the chart. ATC normally communicates an advisory over ATIS that parallel approach procedures are in effect. For example, pilots flying into Sacramento, California may encounter parallel approach procedures. [Figure 5-39]

SIMULTANEOUS

Simultaneous parallel ILS approaches are used at authorized airports that have between 4,300 feet and 9,000 feet separation between runway centerlines. A dedicated final monitor controller is required to monitor separation for this type of approach, which eliminates the need for staggered approaches. Final monitor controllers track aircraft positions and issue instructions to pilots of aircraft observed deviating from the LOC course. [Figure 5-40]

Triple simultaneous approaches are authorized provided the runway centerlines are separated by

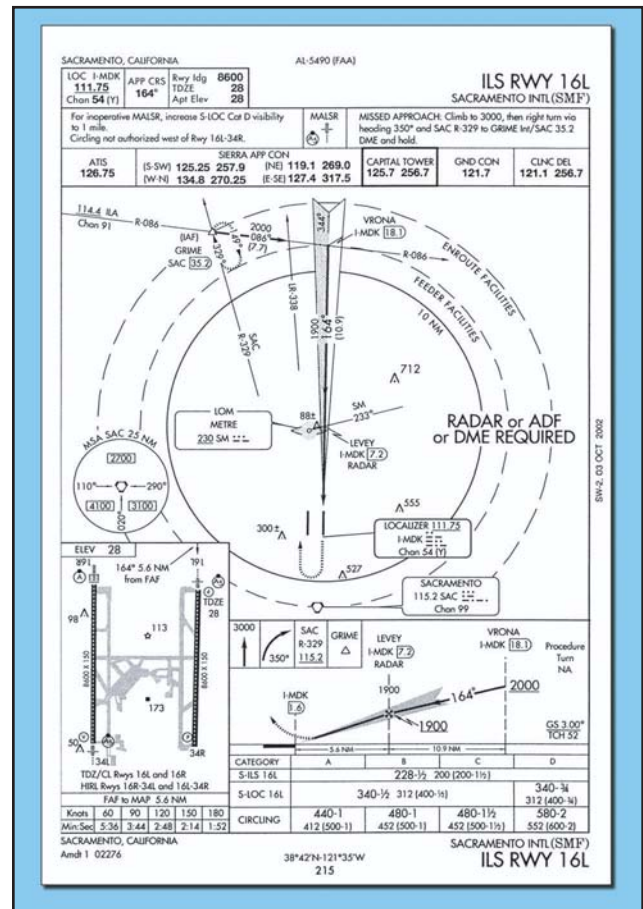

Figure 5-39. Sacramento International (KSMF), Sacramento, California, ILS RWY 16L.

at least 5,000 feet and are below 1,000 feet MSL airport elevation. Additionally, for triple parallel approaches above airport elevations of 1,000 feet MSL, ASR with high-resolution final monitor aids or high update RADAR with associated final monitor aids is required.

As a part of the simultaneous parallel approach approval, normal operating zones and non-transgression zones must be established to ensure proper flight track boundaries for all aircraft. The normal operating zone (NOZ) is the operating zone within which aircraft remain during normal approach operations. The NOZ is typically no less than 1,400 feet wide, with 700 feet of space on either side of the runway centerline. A no transgression zone (NTZ) is a 2,000-foot wide area located between the parallel runway final approach courses. It is equidistant between the runways and indicates an area within which flight is not authorized. [Figure 5-41] Any time an aircraft breaches the NTZ, ATC issues instructions for all aircraft to break off the approach to avoid potential conflict.

PRECISION RUNWAY MONITOR

Simultaneous close parallel (independent) ILS PRM approaches are authorized for use at airports that have

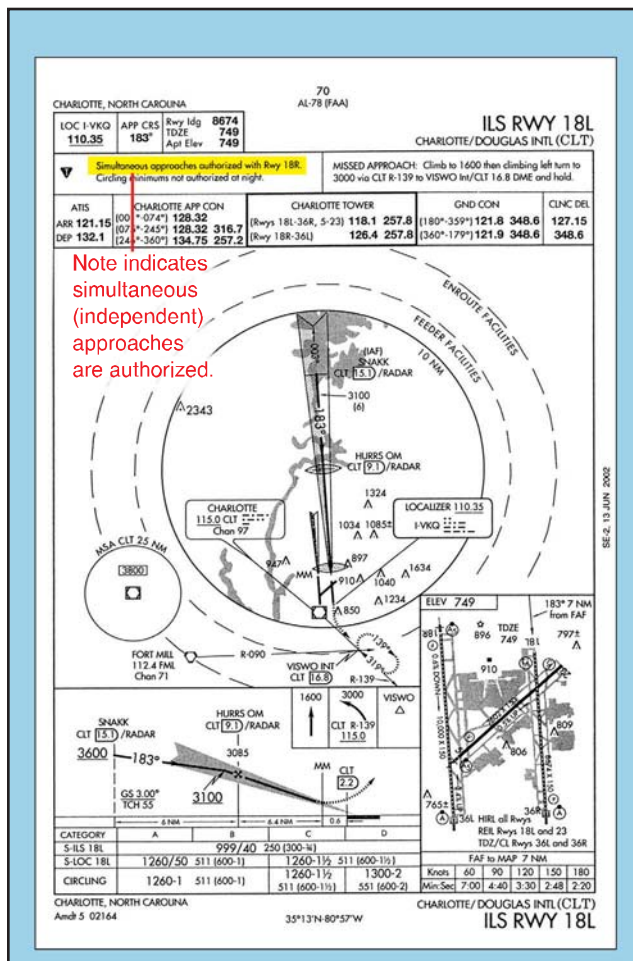

Figure 5-40. Charlotte/Douglas International (KCLT), Charlotte, North Carolina, ILS RWY 18.

parallel runways separated by at least 3,400 feet and no more than 4,300 feet. [Figure 5-42] They are also approved for airports with parallel runways separated by at least 3,000 feet with an offset LOC where the offset angle is at least 2.5° but no more than 3°. The offset LOC approaches are referred to as Simultaneous Offset Instrument Approaches (SOIA) and are discussed in depth later in this chapter.

The PRM system provides the ability to accomplish simultaneous close parallel (independent) ILS approaches and enables reduced delays and fuel savings during reduced visibility operations. It is also the safest method of increasing ILS capacity through the use of parallel approaches. The PRM system incorporates high-update radar with one second or better update time and a high resolution ATC radar display that contains automated tracking software that can track aircraft in real time. Position and velocity is updated each second and a ten second projected position is displayed. The system also incorporates visual and aural alerts for the controllers.

Approval for ILS PRM approaches requires the airport to have a precision runway monitoring system and a

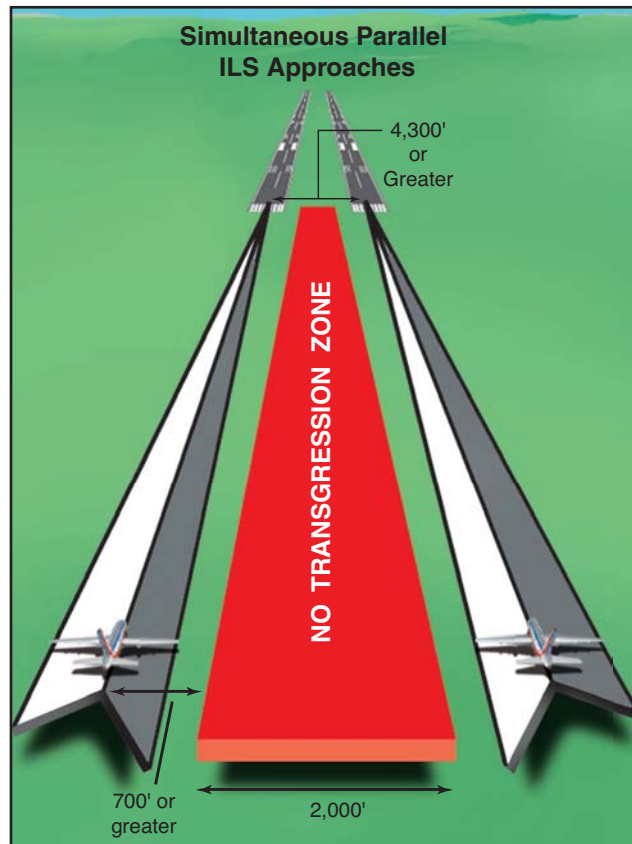

Figure 5-41. Simultaneous Parallel ILS Approach Criteria.

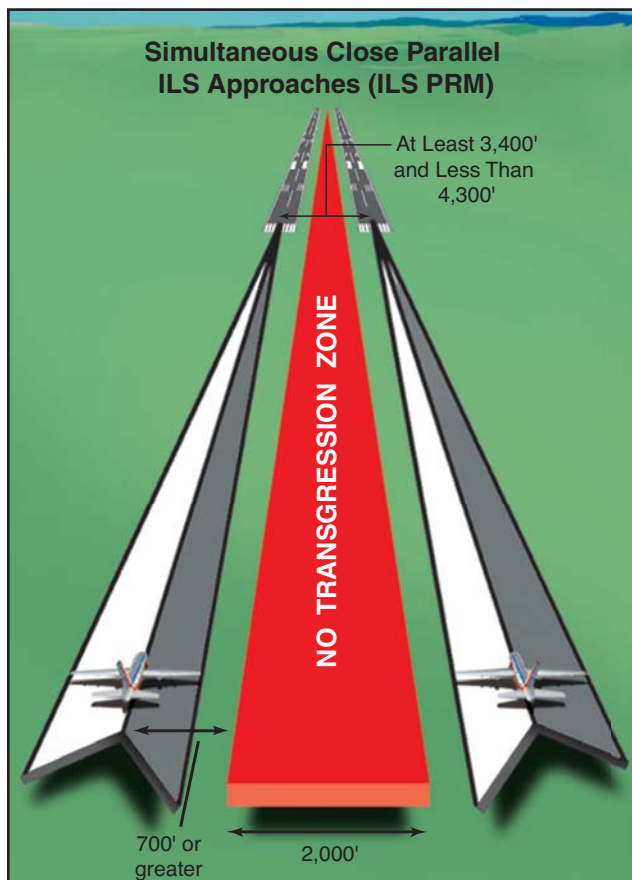

Figure 5-42. Simultaneous Close Parallel ILS Approach (ILS PRM) Criteria.

final monitor controller who can only communicate with aircraft on the final approach course. Additionally, two tower frequencies are required to be used and the controller broadcasts over both frequencies to reduce the chance of instructions being missed. Pilot training is also required for pilots using the PRM system. Part 121 and 135 operators are required to complete training that includes the viewing of one of two videos available from the FAA through the Flight Standards District Office (FSDO) or current employer:

- “RDU Precision Runway Monitor: A Pilot’s Approach.”
- “ILS PRM Approaches, Information for Pilots.”

When pilots or flight crews wish to decline a PRM approach, ATC must be notified immediately and the flight will be transitioned into the area at the convenience of ATC. Flight crews should advise ATC within 200 NM of the landing airport if they are not qualified or not equipped to fly a PRM approach.

The approach chart for the PRM approach typically requires two pages and outlines pilot, aircraft, and procedure requirements necessary to participate in PRM operations. [Figure 5-43] Pilots need to be aware of the differences associated with this type of ILS approach:

- Immediately follow break out instructions as soon as safety permits.
- Listen to both tower frequencies to avoid missed instructions from stuck mikes or blocked transmissions. The final ATC controller can override the radio frequency if necessary.
- Broadcast only over the main tower frequency.
- Disengage the autopilot for breakouts because hand-flown breakouts are quicker.
- Set the Traffic Alert and Collision Avoidance System (TCAS) to TA (traffic advisory) mode only. Resolution Advisory (RA) mode may issue conflicting reports.

It is important to note that descending breakouts may be issued. Additionally, flight crews will never be issued breakout instructions that clear them below the MVA, and they will not be required to descend at more than 1,000 FPM.

CONVERGING

Another method by which ILS approach capacity can be increased is through the use of converging

approaches. Converging approaches may be established at airports that have runways with an angle between 15° and 100° and each runway must have an ILS. Additionally, separate procedures must be established for each approach and each approach must have a MAP at least 3 NM apart with no overlapping of the protected missed approach airspace. Only straight-in approaches are approved for converging ILS procedures. If the runways intersect, the controller must be able to visually separate intersecting runway traffic. Approaches to intersecting runways also have higher minimums with a 700-foot minimum and no less than 2 SM visibility. Pilots are informed of the use of converging ILS approaches by the controller upon initial contact or through ATIS. [Figure 5-44 on page 5-54]

Dallas/Fort Worth International airport is one of the few airports that makes use of converging ILS approaches because its runway configuration has multiple parallel runways and two offset runways. [Figure 5-45 on page 5-55] The approach chart title indicates the use of converging approaches and the notes section highlights other runways that are authorized for converging approach procedures.

MICROWAVE LANDING SYSTEM

The MLS is a precision instrument approach alternative to the ILS. It provides azimuth, elevation, and distance information, as well as a back azimuth capable of providing guidance for missed approach procedures and departures. In addition to straight-in approaches, the MLS system can also provide three-dimensional RNAV type approaches in both computed straight and curved paths. It was initially designed to replace the ILS system and it provided inherent flexibility and broader reception range with the greatest limitation being the capabilities of the airborne equipment installed in individual aircraft.

The MLS has multiple advantages including an increased number of frequencies, compact ground equipment, and complex approach paths. For a variety of reasons, particularly the advent of civil use GPS, MLS installation was deferred, and by 1994 it was officially cancelled by the FAA. Today there are few MLS installations in the U.S. and currently there are no plans for further installations. Furthermore, the MLS equipment required for an MLS approach was not widely installed in aircraft, whereas most new aircraft produced today come with GPS systems. With the limited number of MLS installations around the country, it is highly unlikely that most pilots will ever encounter the MLS approach, and if they do, it is even less likely that the proper equipment would be installed in the aircraft.

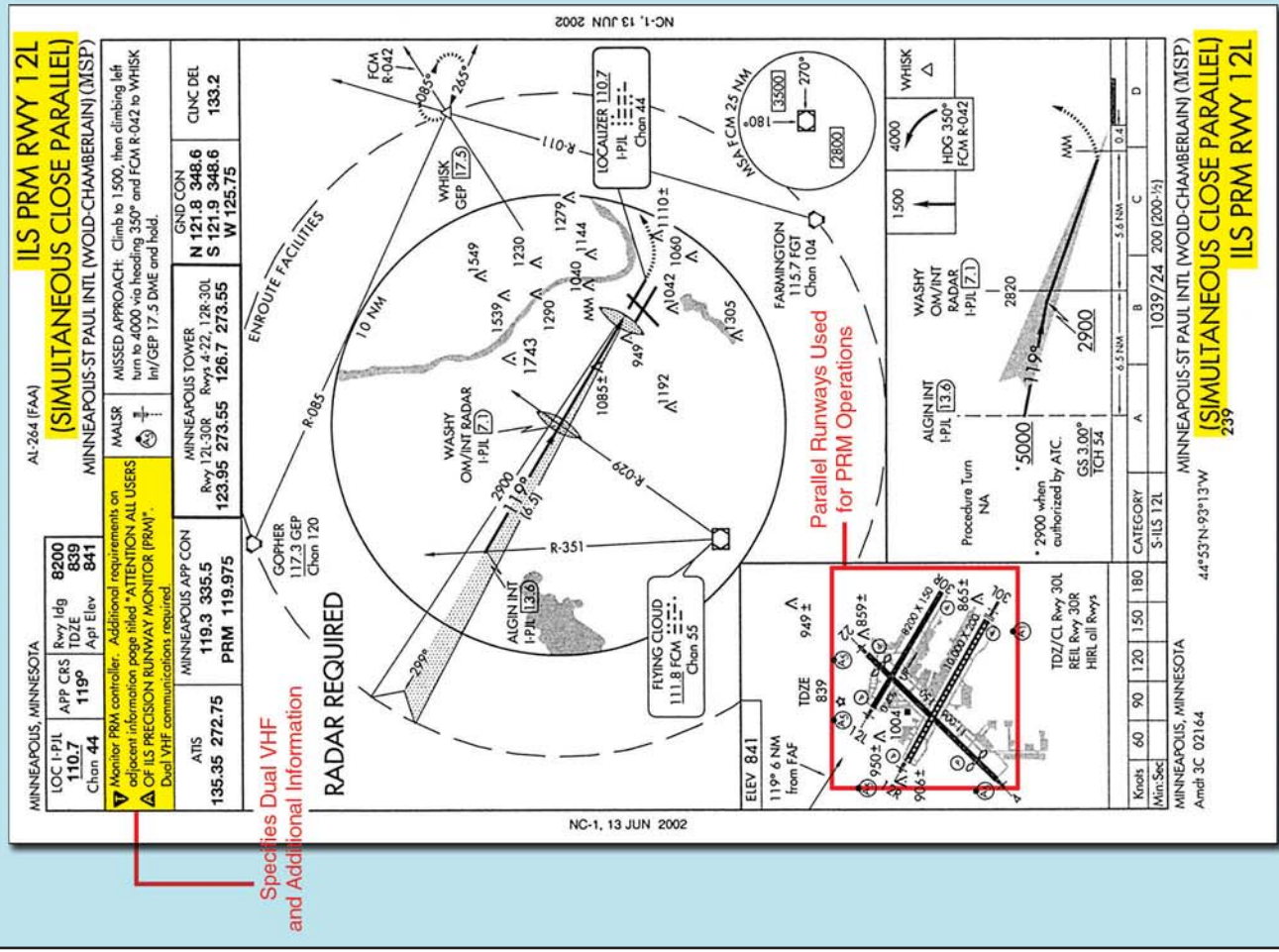

Figure 5-43. Minneapolis, Minnesota, ILS PRM RWY 12L.

MINNEAPOLIS, MINNESOTA
AL-264 (FAA) **ILS PRM RWY 12L**
(SIMULTANEOUS CLOSE PARALLEL)
MINNEAPOLIS-ST PAUL INTL (WOLD-CHAMBERLAIN) (MSP)
Amdt 3C 02108

ATTENTION ALL USERS OF ILS PRECISION RUNWAY MONITOR (PRM)

Special pilot training required before accepting a clearance for a simultaneous close parallel ILS/PRM approach (See Note: Special Pilot Training required**). Pilots shall notify the Minneapolis ARTCC at least 100 miles from Minneapolis Airport if they cannot meet the requirements on this information page. Aircraft unable to conduct this approach may encounter delays.

1. **ATIS.** When the ATIS broadcast advises ILS/PRM approaches are in progress, pilots should brief to fly the ILS/PRM approach. If later advised to expect the ILS approach, the ILS/PRM chart may be used after completing the following briefing items:
 - (a) Minimums and missed approach procedures are unchanged.
 - (b) Monitor frequency no longer required.
2. **Dual VHF Communication required.** To avoid blocked transmissions, each runway will have two frequencies, a primary and a monitor frequency. The tower controller and monitor controller will transmit on both frequencies. Pilots will ONLY transmit on the primary frequency, but will listen to both frequencies. It is important that pilots do not select the monitor frequency until instructed by approach to contact the tower. The volume levels should be set about the same on both radios so that the pilots will be able to hear transmissions on at least one frequency if the other is blocked.
3. **ALL "Breakouts"** are to be hand flown to assure that the maneuver is accomplished in the shortest amount of time. Pilots, when directed by ATC to break off an approach, must assume that an aircraft is blundering toward their course and a breakout must be initiated immediately.
 - (a) ATC Directed "Breakouts". ATC directed breakouts will consist of a turn and a climb or descent. Pilots must always initiate the breakout in response to an air traffic controller instruction. Controllers will give a descending breakout only when there is no other reasonable option available, but in no case will the descent be below minimum vectoring altitude (MVA) which provides at least 1000 feet required obstruction clearance. The MVA is 2500 feet at Minneapolis St. Paul International Airport.
 - (b) Phraseology - "TRAFFIC ALERT": If an aircraft enters the "NO TRANSGRESSION ZONE" (NTZ), the controller will breakout the threatened aircraft on the adjacent approach. The phraseology for the breakout will be:

"TRAFFIC ALERT, [aircraft call sign] TURN (left/right) IMMEDIATELY, HEADING (degrees), CLIMB/DESCEND AND MAINTAIN (altitude)".

****NOTE SPECIAL PILOT TRAINING REQUIRED.** All pilots must complete ILS/PRM Approach Training before accepting a clearance for a simultaneous close parallel ILS/PRM approach. For operations under Part 121, 129, and 135 pilots must comply with FAA approved company training. For operations under Part 91, pilots must be familiar and comply with the information as provided in the Aeronautical Information Manual or as provided at <http://www.faa.gov/AVR/AFS/PRMtraining/>.

MINNEAPOLIS, MINNESOTA
AL-264 (FAA) **ILS PRM RWY 12L**
(SIMULTANEOUS CLOSE PARALLEL)
MINNEAPOLIS-ST PAUL INTL (WOLD-CHAMBERLAIN) (MSP)
Amdt 3C 02108

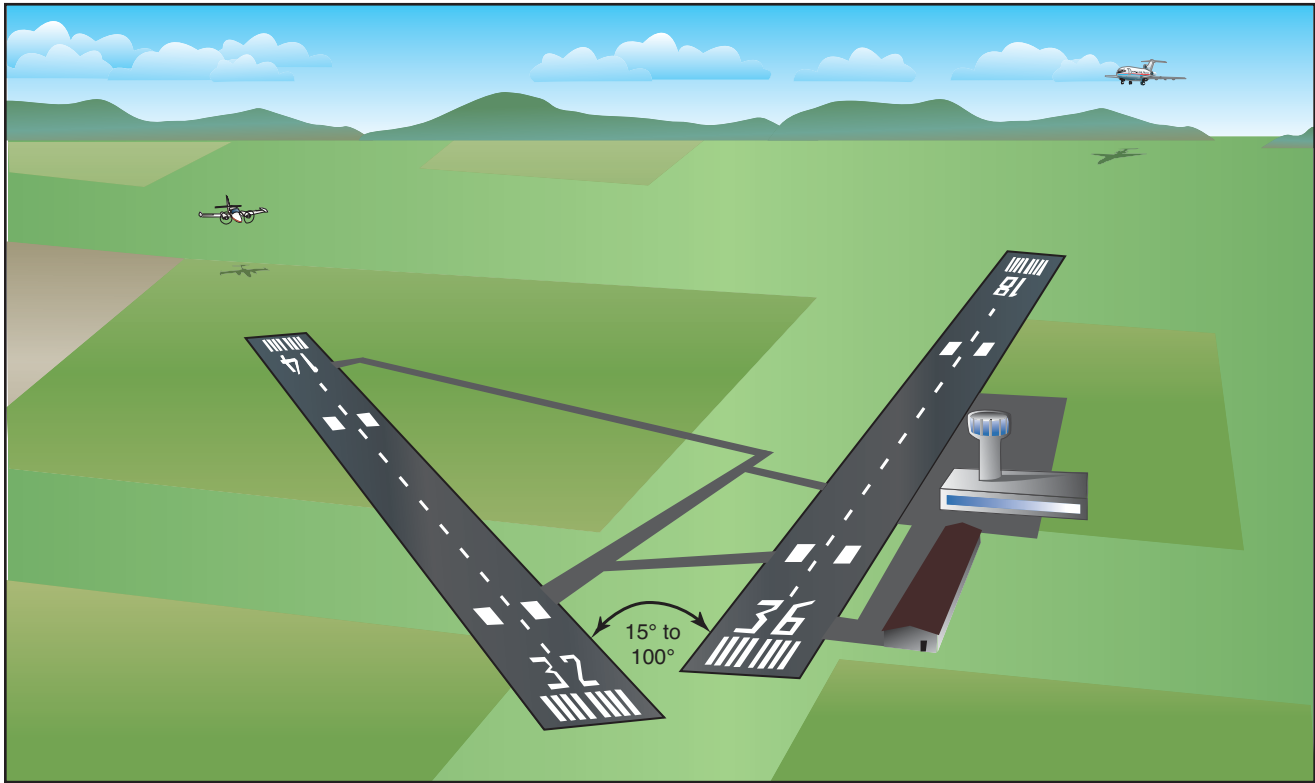

Figure 5-44. Converging Approach Criteria.

Like the ILS, the basic MLS approach requires the final approach course alignment to be within 3° of the extended runway centerline. This type of approach uses a glide slope between 3° and 6.40° , and provides precision landing minimums to 200 feet HAT. Obstacle clearance is based on the glide slope angle used in the approach design. The design criteria differ for each type of MLS approach and incorporate numerous formulas for the derivation of specific course criteria. This information is contained in *FAA Order 8260.3 Volume 3, Chapters 2 and 3*.

Boise, Idaho, is an example of an MLS installation still in use in the U.S. [Figure 5-46 on page 5-56] In the front of the TPP, there is a page containing additional information pertaining to the use of an MLS system. The MLS Channeling and Frequency Pairing Table cross references the appropriate MLS channel with its paired VHF and TACAN frequencies. Ground equipment associated with the MLS operates on the MLS channels, while the MLS angle/data and DME is required to operate using one of the paired VHF or TACAN frequencies. In the case of Boise, the DME system operates on 113.65 MHz, the paired VHF channel for MLS channel 626.

VOR APPROACH

The VOR is one of the most widely used nonprecision approach types in the NAS. VOR approaches use VOR facilities both on and off the airport to establish approaches and include the use of a wide variety of equipment such as DME and TACAN. Due to the wide

variety of options included in a VOR approach, TERPS outlines design criteria for both on and off airport VOR facilities as well as VOR approaches with and without a FAF. Despite the various configurations, all VOR approaches are nonprecision approaches, require the presence of properly operating VOR equipment, and can provide MDAs as low as 250 feet above the runway. VOR also offers a flexible advantage in that an approach can be made toward or away from the navigational facility.

The VOR approach into Missoula International in Missoula, Montana, is an example of a VOR approach where the VOR facility is on the airport and there is no specified FAF. [Figure 5-47 on page 5-57] For a straight-in approach, the final approach course is typically aligned to intersect the extended runway centerline 3,000 feet from the runway threshold, and the angle of convergence between the two does not exceed 30° . This type of VOR approach also includes a minimum of 300 feet of obstacle clearance in the final approach area. The final approach area criteria include a 2 NM wide primary area at the facility that expands to 6 NM wide at a distance of 10 NM from the facility. Additional approach criteria are established for courses that require a high altitude teardrop approach penetration.

When DME is included in the title of the VOR approach, operable DME must be installed in the aircraft in order to fly the approach from the FAF. The use of DME allows for an accurate determination of position without timing, which greatly

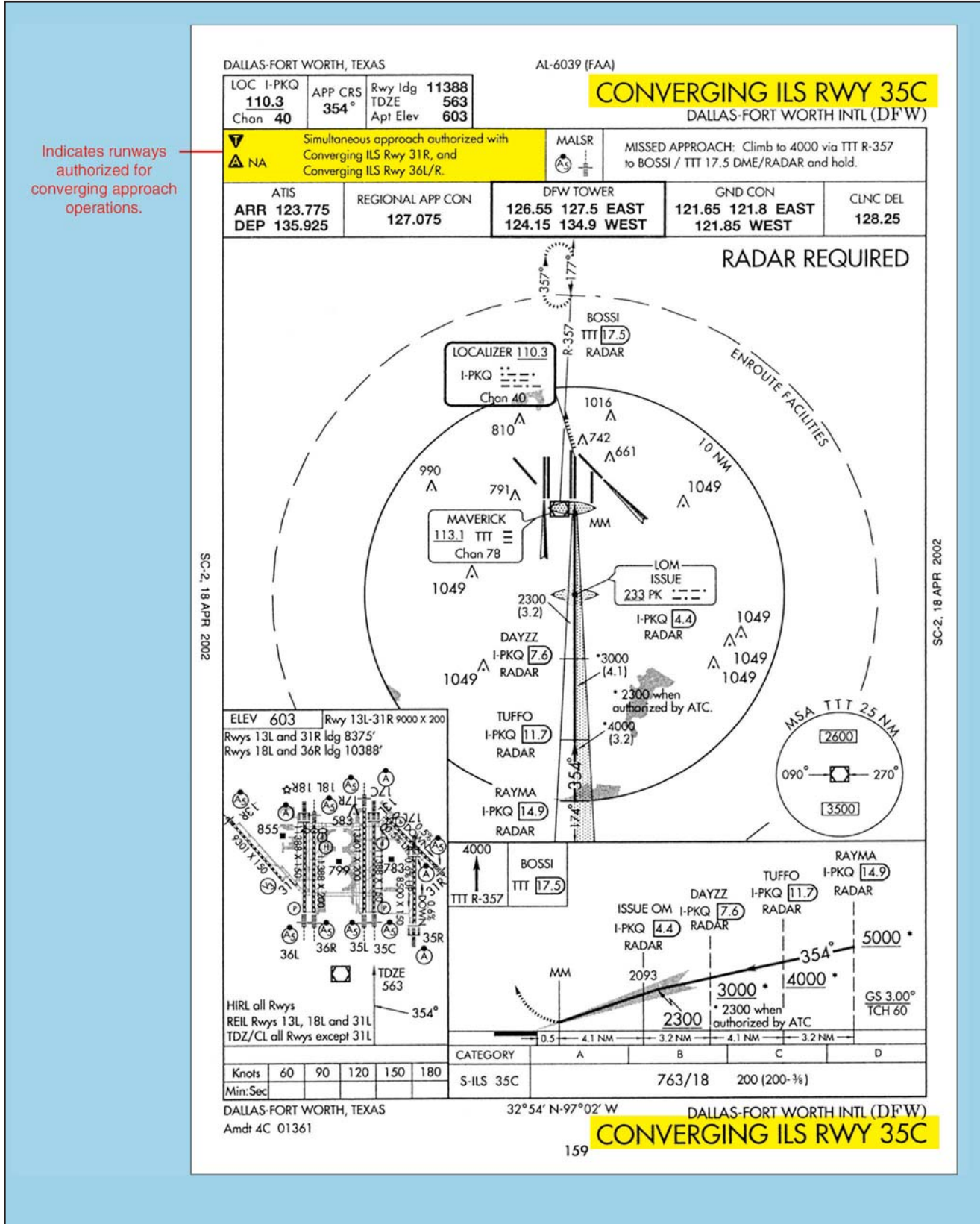

Figure 5-45. Dallas/Fort Worth (KDFW), Dallas/Fort Worth, Texas, CONVERGING ILS RWY 35C.

increases situational awareness throughout the approach. Alexandria, Louisiana, is an excellent example of a VOR/DME approach in which the VOR is off the airport and a FAF is depicted. [Figure 5-48 on page

5-58] In this case, the final approach course is a radial or straight-in final approach and is designed to intersect the runway centerline at the runway threshold with the angle of convergence not exceeding 30°.

BOISE, IDAHO
 52
 AL-57 (FAA)
MLS RWY 28L
 BOISE AIR TERMINAL (GOWEN FIELD) (BOI)

MLS M-BOI APP CRS Rwy ldg 9763
 Chan 626 278° TDZE 2855
 Apt Elev 2868

MALSR
 MISSED APPROACH: Climb to 4500 via BOI R-278 to JIMMI/BOI 12 DME and hold.

ATIS 123.9 290.4
 BOISE APP CON 119.6 269.4
 BOISE TOWER 118.1 257.8
 GND CON 121.7 348.6
 CLNC DEL 125.9 323.2

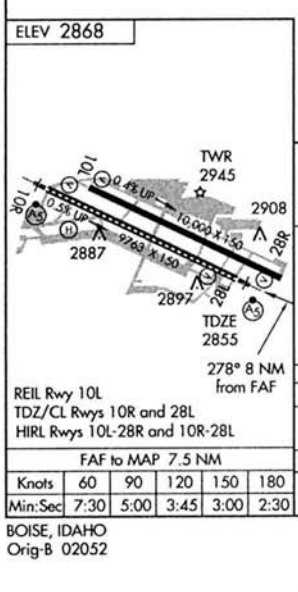
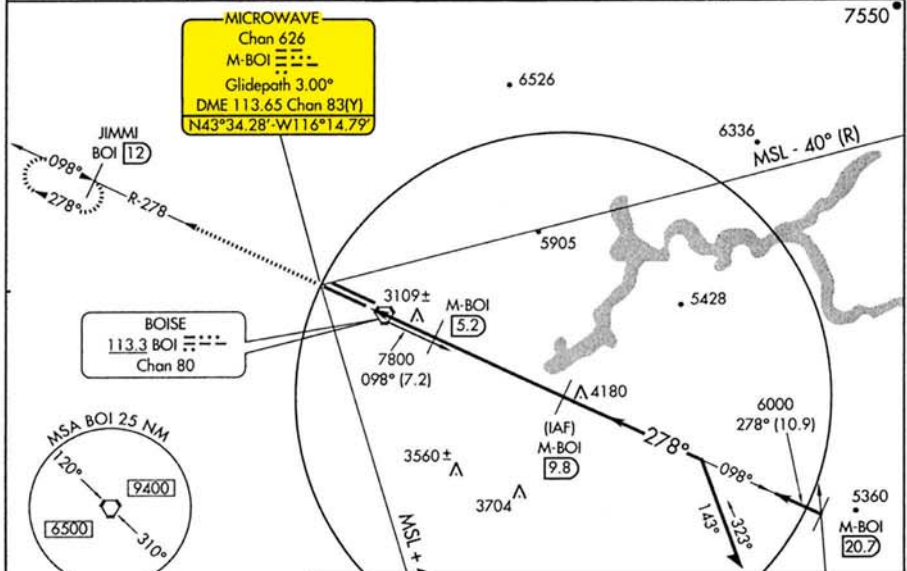

M1

MLS CHANNELING AND FREQUENCY PAIRING TABLE

MLS CHANNEL	VHF FREQUENCY	TACAN CHANNEL	MLS CHANNEL	VHF FREQUENCY	TACAN CHANNEL	MLS CHANNEL	VHF FREQUENCY	TACAN CHANNEL
500	108.10	18X	568	109.45	31Y	636	114.15	88Y
502	108.30	20X	570	109.55	32Y	638	114.25	89Y
504	108.50	22X	572	109.65	33Y	640	114.35	90Y
506	108.70	24X	574	109.75	34Y	642	114.45	91Y
508	108.90	26X	576	109.85	35Y	644	114.55	92Y
510	109.10	28X	578	109.95	36Y	646	114.65	93Y
512	109.30	30X	580	110.05	37Y	648	114.75	94Y
514	109.50	32X	582	110.15	38Y	650	114.85	95Y
516	109.70	34X	584	110.25	39Y	652	114.95	96Y
518	109.90	36X	586	110.35	40Y	654	115.05	97Y
520	110.10	38X	588	110.45	41Y	656	115.15	98Y
522	110.30	40X	590	110.55	42Y	658	115.25	99Y
524	110.50	42X	592	110.65	43Y	660	115.35	100Y
526	110.70	44X	594	110.75	44Y	662	115.45	101Y
528	110.90	46X	596	110.85	45Y	664	115.55	102Y
530	111.10	48X	598	110.95	46Y	666	115.65	103Y
532	111.30	50X	600	111.05	47Y	668	115.75	104Y
534	111.50	52X	602	111.15	48Y	670	115.85	105Y
536	111.70	54X	604	111.25	49Y	672	115.95	106Y
538	111.90	56X	606	111.35	50Y	674	116.05	107Y
540	108.05	17Y	608	111.45	51Y	676	116.15	108Y
542	108.15	18Y	610	111.55	52Y	678	116.25	109Y
544	108.25	19Y	612	111.65	53Y	680	116.35	110Y
546	108.35	20Y	614	111.75	54Y	682	116.45	111Y
548	108.45	21Y	616	111.85	55Y	684	116.55	112Y
550	108.55	22Y	618	111.95	56Y	686	116.65	113Y
552	108.65	23Y	620	113.35	80Y	688	116.75	114Y
554	108.75	24Y	622	113.45	81Y	690	116.85	115Y
556	108.85	25Y	624	113.55	82Y	692	116.95	116Y
558	108.95	26Y	626	113.65	83Y	694	117.05	117Y
560	109.05	27Y	628	113.75	84Y	696	117.15	118Y

Figure 5-46. Boise Air Terminal/Gowan (KBOI), Boise, Idaho, MLS RWY 28L.

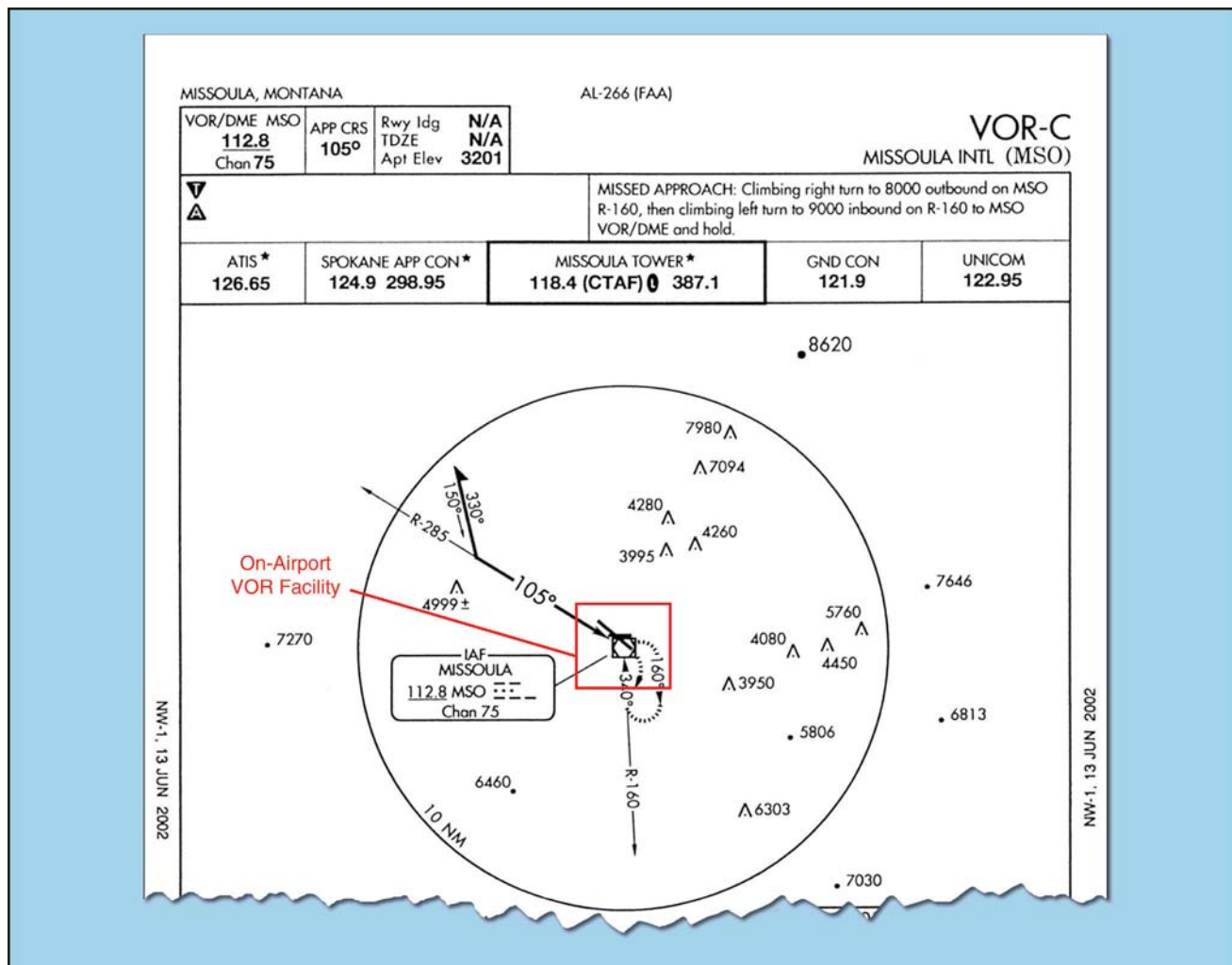

Figure 5-47. Missoula International, Missoula, Montana (KMSO), VOR-C.

The criteria for an arc final approach segment associated with a VOR/DME approach is based on the arc being beyond 7 NM and no farther than 30 NM from the VOR, and depends on the angle of convergence between the runway centerline and the tangent of the arc. Obstacle clearance in the primary area, which is considered the area 4 NM on either side of the arc centerline, is guaranteed by at least 500 feet.

NDB APPROACH

Like the VOR approach, an NDB approach can be designed using facilities both on and off the airport, with or without a FAF, and with or without DME availability. At one time it was commonplace for an instrument student to learn how to fly an NDB approach, but with the growing use of GPS, many pilots no longer use the NDB for instrument approaches. New RNAV approaches are also rapidly being constructed into airports that are served only by NDB. The long-term plan includes the gradual phase out of NDB facilities, and at some point in time, the NDB approach will become nonexistent. Until that time, the NDB provides additional availability for

instrument pilots into many smaller, remotely located airports.

The NDB Runway 9 approach at Charleston Executive Airport, is an example of an NDB approach established with an on-airport NDB that does not incorporate a FAF. [Figure 5-49 on page 5-59] In this case, a procedure turn or penetration turn is required to be a part of the approach design. For the NDB to be considered an on-airport facility, the facility must be located within one mile of any portion of the landing runway for straight-in approaches and within one mile of any portion of usable landing surface for circling approaches. The final approach segment of the approach is designed with a final approach area that is 2.5 NM wide at the facility, and increases to 8 NM wide at 10 NM from the facility. Additionally, the final approach course and the extended runway centerline angle of convergence cannot exceed 30° for straight-in approaches. This type of NDB approach is afforded a minimum of 350 feet obstacle clearance.

When a FAF is established for an NDB approach, the approach design criteria changes. It also takes into

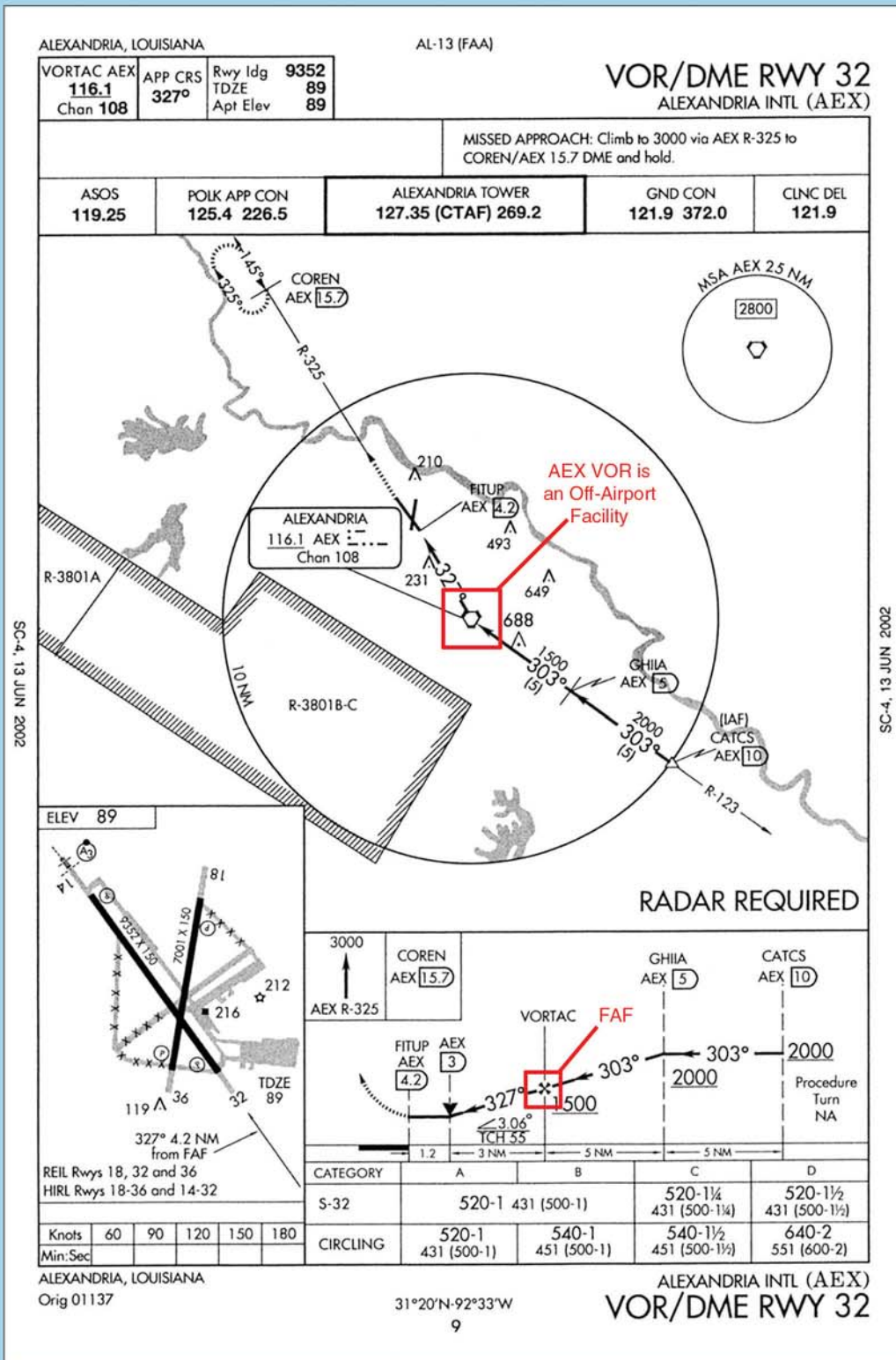

Figure 5-48. Alexandria International, Alexandria, Louisiana (KAEX), VOR/DME RWY 32.

CHARLESTON, SOUTH CAROLINA

AL-5354 (FAA)

NDB JZI 283	APP CRS 102°	Rwy Idg TDZE Apt Elev	5000 20 20
-----------------------	------------------------	-----------------------------	---------------------------------------

NDB RWY 9
CHARLESTON EXECUTIVE (JZI)

▼ Use Charleston altimeter setting.	MISSED APPROACH: Climbing right turn to 1600 in JZI NDB holding pattern.	
CHARLESTON APP CON 120.7 306.925	CLNC DEL 127.15	UNICOM 122.8 (CTAF) 0

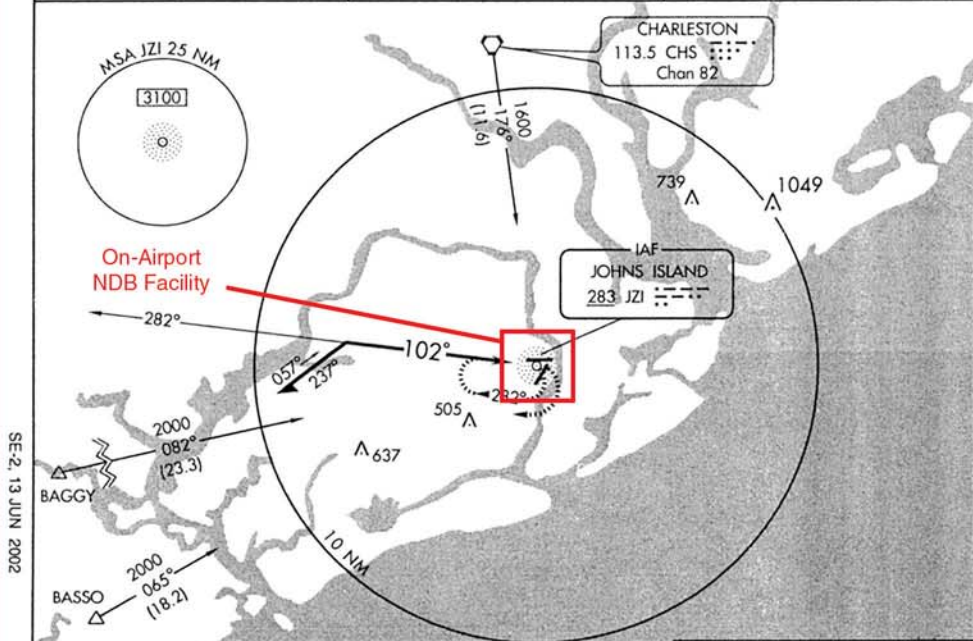

SE-2, 13 JUN 2002

SE-2, 13 JUN 2002

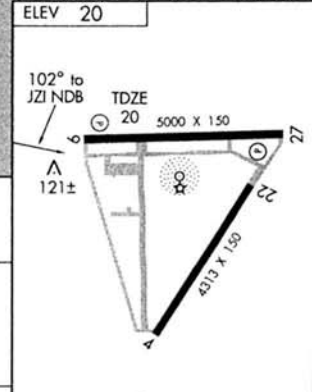
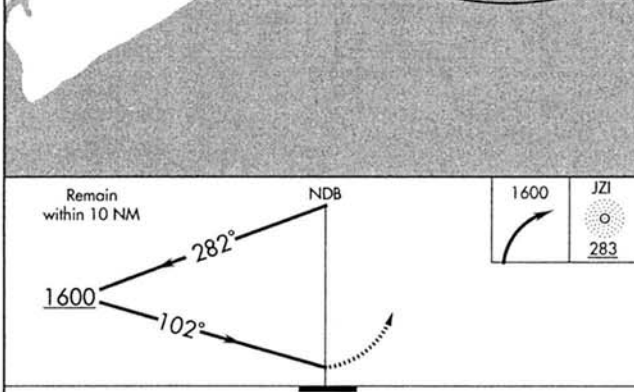

CATEGORY	A	B	C	D
S-9	700-1	680 (700-1)	700-2 680 (700-2)	700-2¼ 680 (700-2¼)
CIRCLING	700-1	680 (700-1)	700-2 680 (700-2)	700-2¼ 680 (700-2¼)

MIRL Rwy 4-22	0				
HIRL Rwy 9-27	0				
Knots	60	90	120	150	180
Min:Sec					

CHARLESTON, SOUTH CAROLINA
Amdt 7A 02164

32°42'N-80°00'W
67

CHARLESTON EXECUTIVE (JZI)
NDB RWY 9

Figure 5-49. Charleston Executive (KJZI), Charleston, South Carolina, NDB RWY 9.

account whether or not the NDB is located on or off the airport. Additionally, this type of approach can be made both moving toward or away from the NDB facility. The St. Mary's, Alaska, NDB DME RWY 16 [Figure 5-50] is an approach with a FAF using an on-airport

NDB facility that also incorporates the use of DME. In this case, the NDB has DME capabilities from the LOC approach system installed on the airport. While the alignment criteria and obstacle clearance remain the same as an NDB approach without a FAF, the final

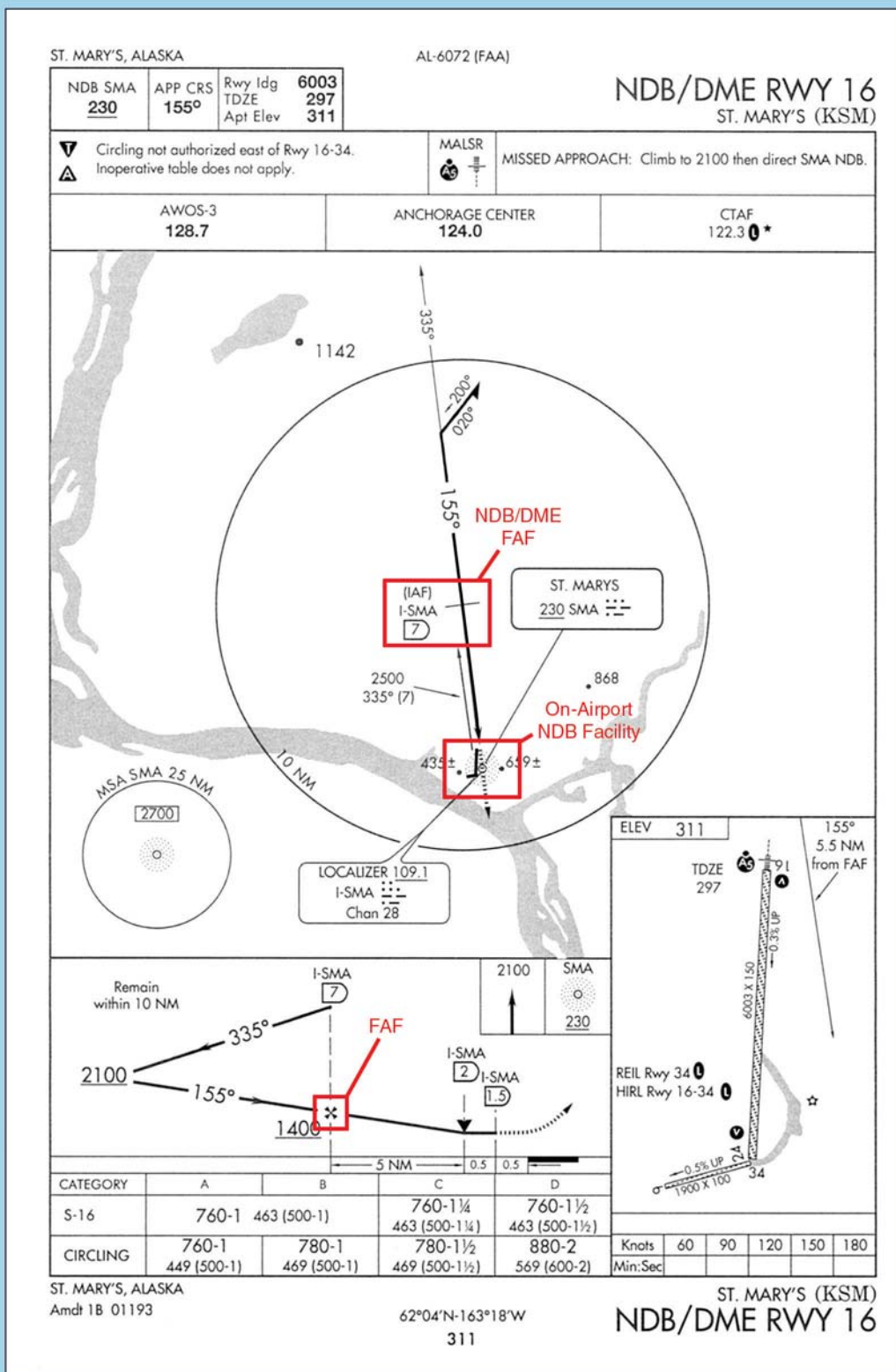

Figure 5-50. St. Mary's (PASM), St. Mary's, Alaska, NDB DME RWY 16.

approach segment area criteria changes to an area that is 2.5 NM wide at the facility and increases to 5 NM wide, 15 NM from the NDB.

RADAR APPROACHES

The two types of radar approaches available to pilots when operating in the NAS are PAR and ASR. Radar approaches may be given to any aircraft at the pilot's request. ATC may also offer radar approach options to aircraft in distress regardless of the weather conditions, or as necessary to expedite traffic. Despite the control exercised by ATC in a radar approach environment, it remains the pilot's responsibility to ensure the approach and landing minimums listed for the approach are appropriate for the existing weather conditions considering personal approach criteria certification and company OpsSpecs.

Perhaps the greatest benefit of either type of radar approach is the ability to use radar to execute a "no-gyro" approach. Assuming standard rate turns, an air traffic controller can indicate when to begin and end turns. If available, pilots should make use of this approach when the heading indicator has failed and partial panel instrument flying is required.

Information about radar approaches is published in tabular form in the front of the TPP booklet. PAR, ASR, and circling approach information including runway, DA, DH, or MDA, height above airport (HAA), HAT, ceiling, and visibility criteria are outlined and listed by specific airport.

Regardless of the type of radar approach in use, ATC monitors aircraft position and issues specific heading and altitude information throughout the entire approach. Particularly, lost communications procedures should be briefed prior to execution to ensure pilots have a comprehensive understanding of ATC expectations if radio communication were lost. ATC also provides additional information concerning weather and missed approach instructions when beginning a radar approach. [Figure 5-51]

PRECISION APPROACH RADAR

PAR provides both vertical and lateral guidance, as well as range, much like an ILS, making it the most precise radar approach available. The radar approach, however, is not able to provide visual approach indications in the cockpit. This requires the flight crew to listen and comply with controller instructions. PAR approaches are rare, with most of the approaches used in a military setting; any opportunity to practice this type of approach is beneficial to any flight crew.

The final approach course of a PAR approach is always directly aligned with the runway centerline, and the associated glide slope is typically no less than 2° and no more than 3°. Obstacle clearance for the final approach area is based on the particular established glide slope angle and the exact formula is outlined in Chapter 10 of TERPS. [Figure 5-52 on page 5-62]

AIRPORT SURVEILLANCE RADAR

ASR approaches are typically only approved when necessitated for an ATC operational requirement, or in

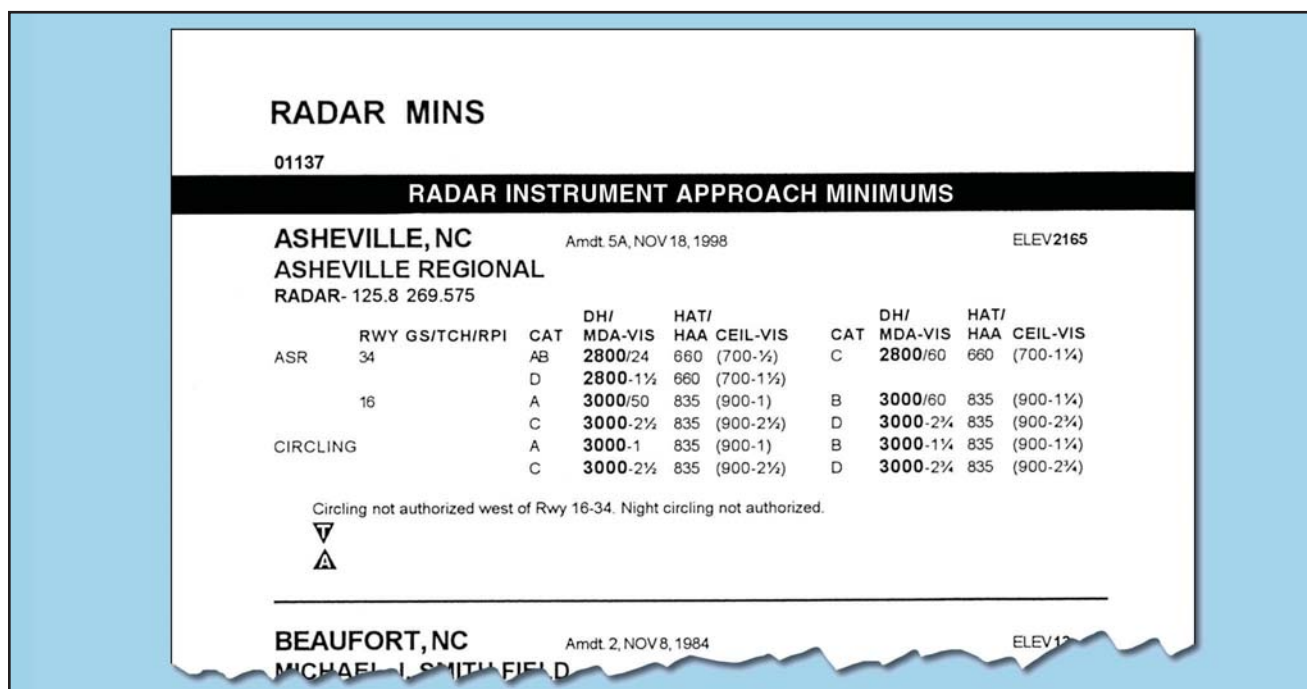

Figure 5-51. Asheville Regional (KAVL), Asheville, NC, Radar Instrument Approach Minimums.

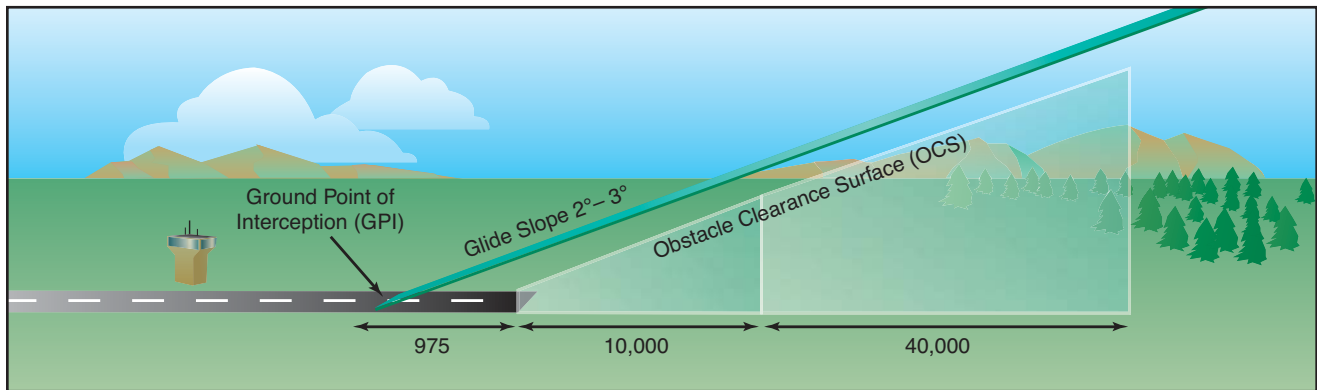

Figure 5-52. PAR Final Approach Area Criteria.

an unusual or emergency situation. This type of radar only provides heading and range information, although the controller can advise the pilot of the altitude where the aircraft should be based on the distance from the runway. An ASR approach procedure can be established at any radar facility that has an antenna within 20 NM of the airport and meets the equipment requirements outlined in Order 8200.1 *U.S. Standard Flight Inspection Manual* (latest version). ASR approaches are not authorized for use when **Center Radar ARTS processing (CENRAP)** procedures are in use due to diminished radar capability.

The final approach course for an ASR approach is aligned with the runway centerline for straight-in approaches and aligned with the center of the airport for circling approaches. Within the final approach area, the pilot is also guaranteed a minimum of 250 feet obstacle clearance. ASR descent gradients are designed to be relatively flat, with an optimal gradient of 150 feet per mile and never exceeding 300 feet per mile.

LOCALIZER APPROACHES

As an approach system, the localizer is an extremely flexible approach aid that, due to its inherent design,

provides many applications for a variety of needs in instrument flying. An ILS glide slope installation may be impossible due to surrounding terrain. For whatever reason, the localizer is able to provide four separate applications from one approach system:

- Localizer Approach.
- Localizer/DME Approach.
- Localizer Back Course Approach.
- Localizer-type Directional Aid (LDA).

LOCALIZER AND LOCALIZER DME

The localizer approach system can provide both precision and nonprecision approach capabilities to a pilot. As a part of the ILS system, the localizer provides horizontal guidance for a precision approach. Typically, when the localizer is discussed, it is thought of as a nonprecision approach due to the fact that either it is the only approach system installed, or the glide slope is out of service on the ILS. In either case, the localizer provides a nonprecision approach using a localizer transmitter installed at a specific airport. [Figure 5-53]

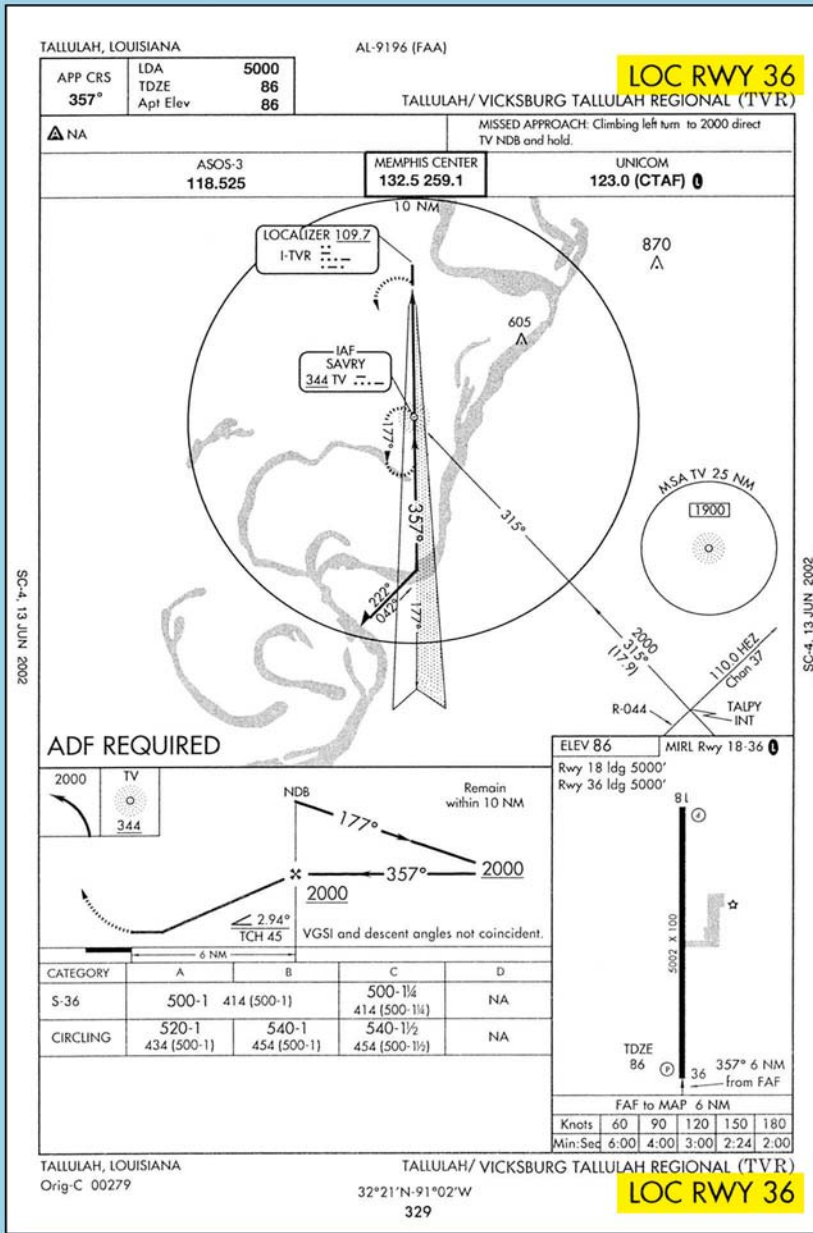

Figure 5-53. Vicksburg Tallulah Regional (KTVR), Tallulah/Vicksburg, Louisiana, LOC RWY 36.

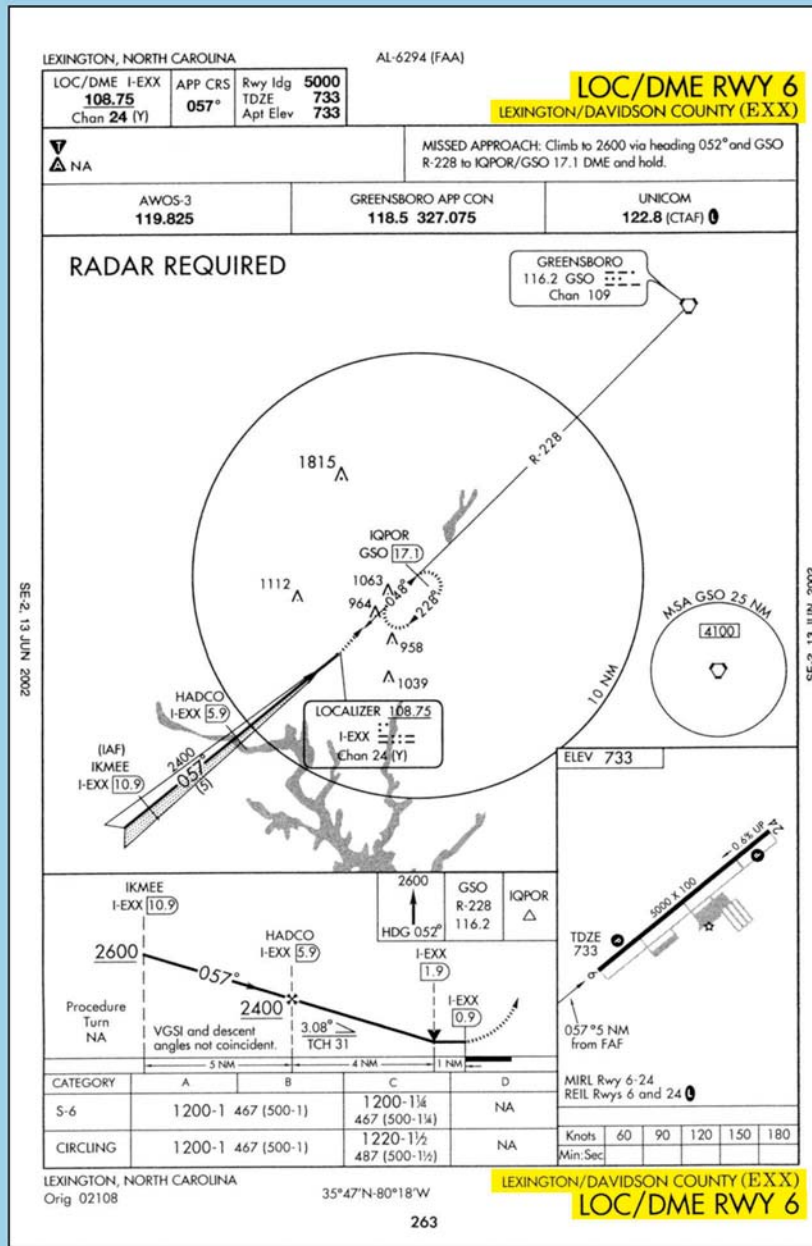

Figure 5-54. Davidson County (KEXX), Lexington, North Carolina, LOC DME RWY 6.

TERPS provide the same alignment criteria for a localizer approach as it does for the ILS since it is essentially the same approach without vertical guidance stemming from the glide slope. A localizer is always aligned within 3° of the runway, and it is afforded a minimum of 250 feet obstacle

clearance in the final approach area. In the case of a localizer DME (LOC DME) approach, the localizer installation has a collocated DME installation that provides distance information required for the approach. [Figure 5-54]

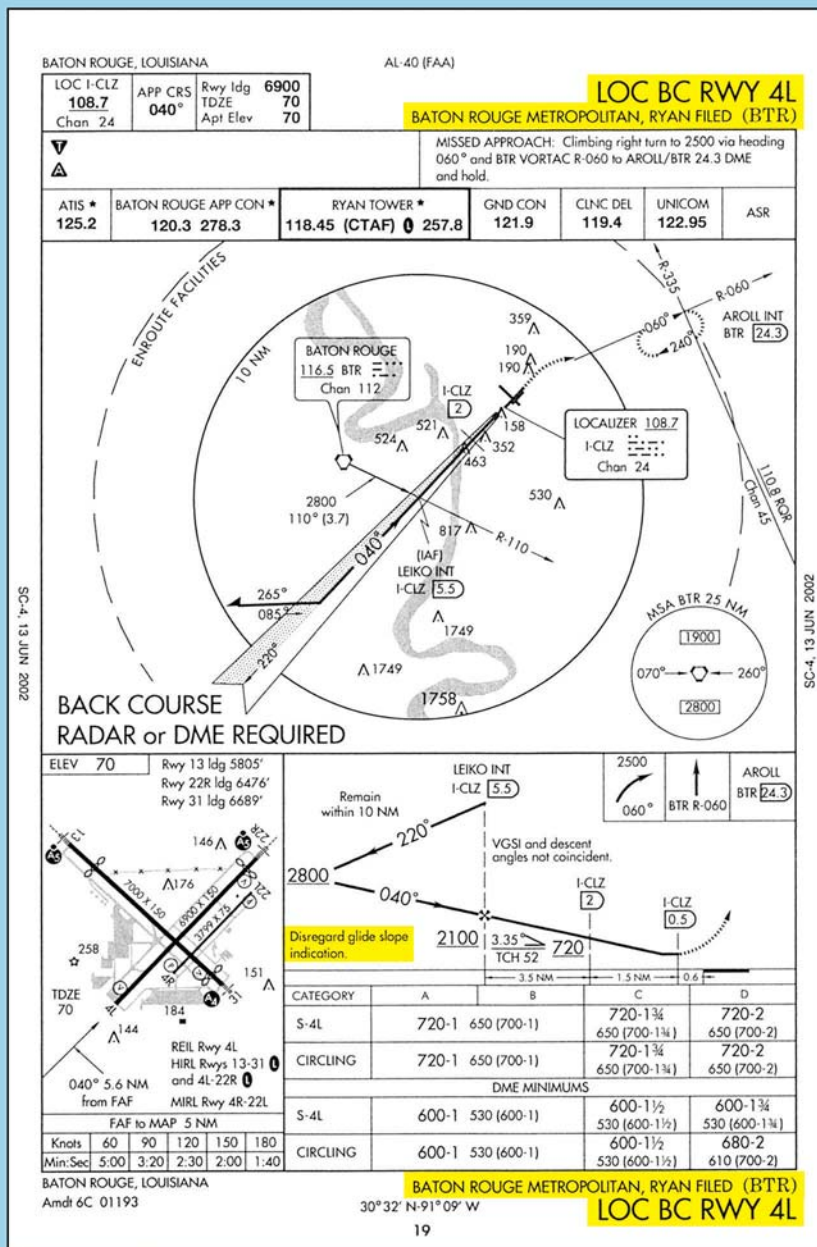

Figure 5-55. Baton Rouge Metro/Ryan (KBTR), Baton Rouge, Louisiana, LOC BC RWY 4L.

LOCALIZER BACK COURSE

In cases where an ILS is installed, a back course may be available in conjunction with the localizer. Like the localizer, the back course does not offer a glide slope, but remember that the back course can project a false glide slope signal and the glide slope should

be ignored. Reverse sensing will occur on the back course using standard VOR equipment. With an HSI (horizontal situation indicator) system, reverse sensing is eliminated if it is set appropriately to the front course. [Figure 5-55]

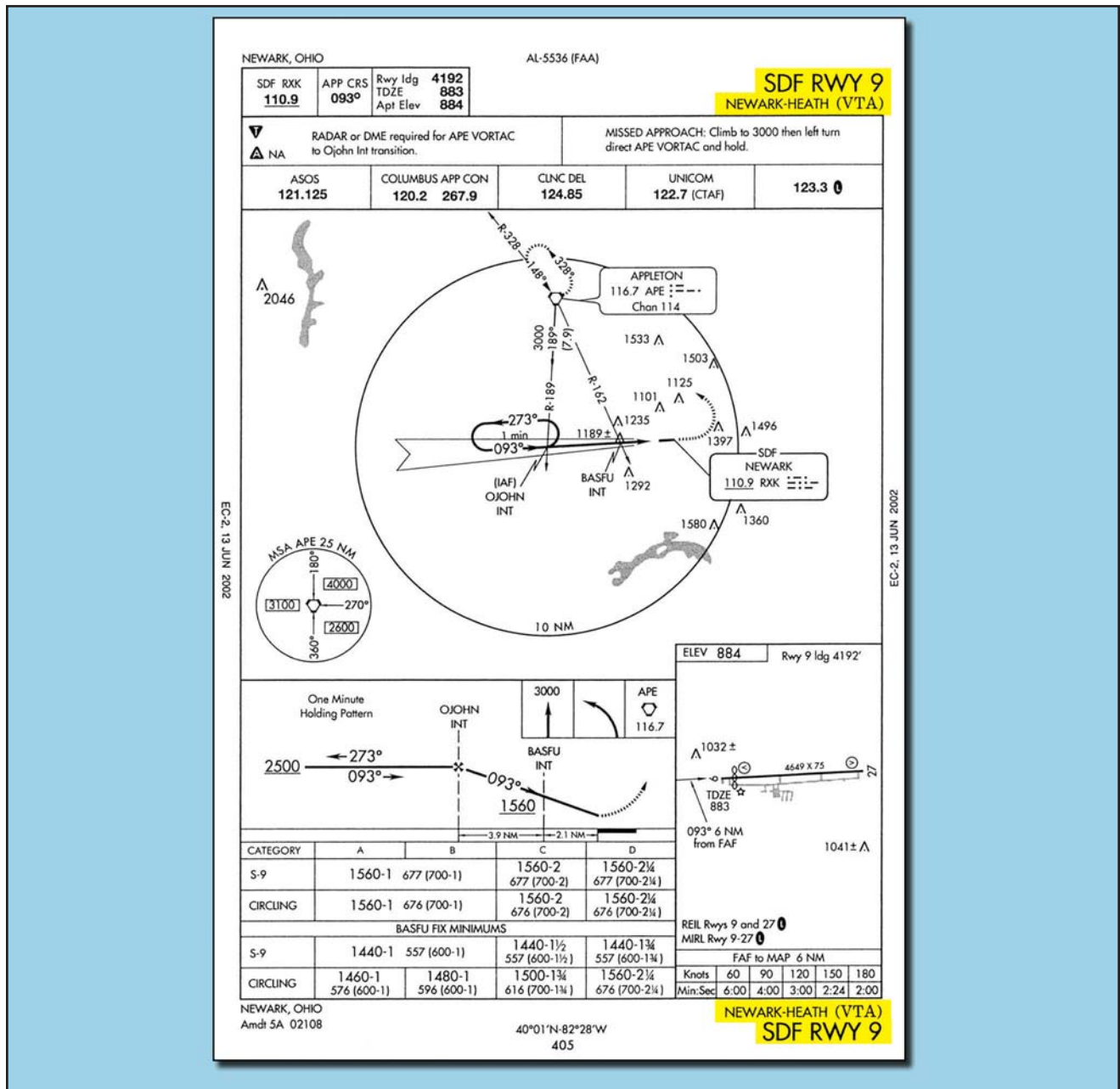

Figure 5-57. Newark-Heath (KVTA), Newark, Ohio, SDF RWY 9.

approach authorized with LDA PRM RWY XXX.” It is the goal of the FAA to begin conducting SOIA operations at San Francisco International Airport in 2003.

SIMPLIFIED DIRECTIONAL FACILITY

The SDF is another instrument approach system that is not as accurate as the LOC approach facilities. Like the LOC type approaches, the SDF is an alternative approach that may be installed at an airport for a variety of reasons, including terrain. The final approach course width of an SDF system is set at either 6° or 12°. The SDF is a nonprecision approach since it only provides lateral guidance to the runway.

For straight-in SDF approaches, the angle of convergence for the final approach course and the extended runway centerline is 30° or less, and if the angle of convergence is beyond 30°, the SDF will only have circling minimums. An SDF approach is provided a minimum of 250 feet obstacle clearance for straight-in approaches while in the final approach area, which is an area defined for a 6° course: 1,000 feet at or abeam the runway threshold expanding to 19,228 feet 10 NM from the threshold. The same final approach area for a 12° course is larger. This type of approach is also designed with a maximum descent gradient of 400 feet per NM, unless circling only minimums are authorized. [Figure 5-57]

As the traditional, ground-based NAVAIDs are phased out, the new components of the satellite-based systems will be implemented, and the first major upgrade, the addition of WAAS IFR operations, is scheduled to begin in 2003. Once WAAS is fully IFR capable, additional, more precise minimums are slated to be

developed, as is the implementation of LAAS. Together WAAS and LAAS will provide a fully augmented precision satellite navigation system, which will be backed up by a smaller, but effective safety net of traditional NAVAIDs.